

# RM Series™

## Two-way Radios

*User Guide*



Models RMU2080 & RMV2080

MOTOROLA, MOTO, MOTOROLA SOLUTIONS and the Stylized M Logo are trademarks or registered trademarks of Motorola Trademark Holdings, LLC and are used under license. All other trademarks are the property of their respective owners. ©2013 Motorola, Inc. All rights reserved. Printed in Malaysia.

Motorola Solutions, Inc. 1301 East Algonquin Road Schaumburg, Illinois 60196,  
U.S.A. 800-367-2346 [www.motorolasolutions.com](http://www.motorolasolutions.com)

<b>CONTENTS</b>	
<b>Contents</b> .....	<b>1</b>
<b>Safety</b> .....	<b>4</b>
<b>Introduction</b> .....	<b>5</b>
Package Contents .....	5
<b>Batteries and Chargers</b>	
<b>Safety Information</b> .....	<b>7</b>
Operational Safety Guidelines .....	8
<b>FCC Licensing Information</b> .....	<b>9</b>
Interference Information .....	9
<b>Radio Overview</b> .....	<b>11</b>
Parts of the Radio .....	11
On/Off/Volume Knob .....	12
Channel Selector Knob .....	12
Accessory Connector .....	12
Model Label .....	12
Microphone .....	12
Antenna .....	12
LED Indicator .....	12
Side Buttons .....	12
The Lithium-Ion (Li-Ion) Battery .....	12
<b>Battery Features</b> .....	<b>14</b>
About the Li-Ion Battery .....	14
Battery Recycling and Disposal .....	15
Installing the Lithium-Ion (Li-Ion) Battery .....	16
Removing the Lithium-Ion (Li-Ion) Battery .....	16
Power Supply, Adaptor and Drop-in Tray Charger .....	19
Battery Life Information .....	20
Charging the Battery .....	22

<b>Getting Started</b> .....	<b>29</b>	Reading CTCSS/DPL Values .....	40
Turning radio ON/OFF .....	29	Reading Auto-Scan Values .....	41
Adjusting Volume .....	29	Programming Frequencies, Codes, Auto-Scan an Active Channels .....	41
Selecting a Channel .....	29	Programming Mode FAQ .....	42
Talking and Monitoring .....	29	Programming Values Example .....	43
Receiving a Call .....	30	Example of Programming a Frequency .....	43
Talk Range .....	30	Example of Programming a Code .....	44
Radio LED Indicators .....	32	Example of Programming Auto-Scan .....	45
Hands-Free Use/VOX .....	33	Other Programming Features .....	46
With Compatible VOX Accessories .....	33	Scan .....	46
Setting VOX Sensitivity .....	34	Editing Scan List .....	47
Microphone Gain .....	34	Nuisance Channel Delete .....	47
Battery Save .....	34	CPS (Computer Programming Software) .....	48
Reset to Factory Defaults .....	34	Time-Out Timer .....	49
End of Transmission Tone (Roger Beep Tone) .....	35	Power Select .....	49
<b>Programming Features</b> .....	<b>36</b>	Battery Type Setting .....	49
Programming Mode .....	36	Call Tones .....	49
Reading the Values the Radio Signals You .....	36	Scramble  .....	50
Entering Programming Mode .....	39	Reverse Burst .....	50
Reading Frequencies Values .....	39		

Cloning Radios . . . . .	51	<b>Motorola Limited Warranty for the United States and Canada . . . . .</b>	<b>76</b>
Cloning with a Multi Unit Charger (MUC) . . . . .	51	<b>Accessories . . . . .</b>	<b>80</b>
Cloning Radio using the Radio to Radio (R2R) Cloning Cable (Optional Accessory) . . . . .	53	Audio Accessories . . . . .	80
Cloning using the CPS (Computer Programming Software) . . . . .	55	Battery . . . . .	80
<b>Troubleshooting . . . . .</b>	<b>56</b>	Carry Accessories . . . . .	81
<b>Use and Care . . . . .</b>	<b>60</b>	Power Supplies AC Pin Adaptors. . . . .	81
<b>Frequency and Code Charts . . . . .</b>	<b>61</b>	Software Applications. . . . .	81
RMV VHF Frequencies Chart . . . . .	61	Cables . . . . .	81
RMV2080 - VHF Default Frequencies Chart . . . . .	63	Chargers . . . . .	81
RMU UHF Frequencies Chart . . . . .	65	Power Supplies . . . . .	82
RMU2080 - UHF Default Frequencies Chart . . . . .	69	<b>RM Series Features Summary . . . . .</b>	<b>83</b>
CTCSS and PL/DPL Codes . . . . .	71	<b>Programmable Buttons Chart . . . . .</b>	<b>93</b>
		<b>Icons Chart . . . . .</b>	<b>94</b>

## SAFETY

### PRODUCT SAFETY AND RF EXPOSURE COMPLIANCE



Caution

Before using this product, read the operating instructions and RF energy awareness information contained in the Product Safety and RF Exposure booklet enclosed with your radio.

#### ATTENTION!

This radio is restricted to occupational use only to satisfy FCC RF energy exposure requirements.

For a list of Motorola-approved antennas, batteries, and other accessories, visit the following website which lists approved accessories:

[www.motorolasolutions.com/RMseries](http://www.motorolasolutions.com/RMseries)

## INTRODUCTION

Thank you for purchasing the Motorola® RM Series Radio. This radio is a product of Motorola's 80 plus years of experience as a world leader in the designing and manufacturing of communications equipment. The RM Series™ radios provide cost-effective communications for businesses such as retail stores, restaurants, schools, construction sites, manufacturing, property, hotel management and more. Motorola Business two-way radios are the perfect communications solution for all of today's fast-paced industries. **Note:** Read this user guide carefully to ensure you know how to properly operate the radio before use

**Business Radios,  
Mailstop 1C15, Motorola  
8000 West Sunrise Boulevard  
Plantation, Florida 33322**

### PACKAGE CONTENTS

- Radio
- Holster
- Lithium-Ion Battery
- Power Supply
- Quick Reference Guide
- Warranty Card
- Drop-in Tray Charger
- Product Safety & RF Exposure Booklet

For a copy of a large-print version of this user guide or for product-related questions, contact:

**1-800-448-6686 in the USA**

**1-866-522-5210 on your TTY (Text Telephone)**

For product information visit us at:

**[www.motorolasolutions.com/RMseries](http://www.motorolasolutions.com/RMseries)**



## BATTERIES AND CHARGERS SAFETY INFORMATION

This document contains important safety and operating instructions. Read these instructions carefully and save them for future reference.

Before using the battery charger, read all the instructions and cautionary markings on

- The charger,
  - The battery, and
  - The radio using the battery
1. To reduce risk of injury, charge only the rechargeable Motorola-authorized batteries. Other batteries may explode, causing personal injury and damage.
  2. Use of accessories not recommended by Motorola may result in risk of fire, electric shock, or injury.
  3. To reduce risk of damage to the electric plug and cord, pull by the plug rather than the cord when disconnecting the charger.
  4. An extension cord should not be used unless absolutely necessary. Use of an improper extension cord could result in risk of fire and electric shock. If an extension cord must be used, make sure that the cord size is 18AWG for lengths up to 6.5 feet (2.0 m), and 16AWG for lengths up to 9.8 feet (3.0 m).
  5. To reduce risk of fire, electric shock, or injury, do not operate the charger if it has been broken or damaged in any way. Take it to a qualified Motorola service representative.
  6. Do not disassemble the charger; it is not repairable and replacement parts are not available. Disassembly of the charger may result in risk of electrical shock or fire.
  7. To reduce risk of electric shock, unplug the charger from the AC outlet before attempting any maintenance or cleaning

## **OPERATIONAL SAFETY GUIDELINES**

- Turn the radio OFF when charging battery.
- The charger is not suitable for outdoor use. Use only in dry locations/conditions.
- Connect charger only to an appropriately fused and wired supply of the correct voltage (as specified on the product).
- Disconnect charger from line voltage by removing main plug.
- The outlet to which this equipment is connected should be nearby and easily accessible.
- Maximum ambient temperature around the power supply equipment must not exceed 40°C (104°F).
- Make sure that the cord is located where it will not be stepped on, tripped over, or subjected to water, damage, or stress.

# FCC LICENSING INFORMATION

## INTERFERENCE INFORMATION

This device complies with Part 15 of the FCC Rules. Operation is subject to the condition that this device does not cause harmful interference.

RM Series Business two-way radios operate on radio frequencies that are regulated by the Federal Communications Commission

(FCC). To transmit on these frequencies, you are required to have a license issued by the FCC. Application is made available on FCC Form 601 and Schedules D, H, and Remittance Form 159.

To obtain these FCC forms, request document 000601 which includes all forms and instructions. If you wish to have the document faxed, mailed or have questions, use the following contact information.

<b>Faxed contact the Fax-On- Demand system at:</b>	<b>Mailed call the FCC forms hotline at:</b>	<b>Questions regarding FCC license contact the FCC at:</b>
1-202-418-0177	1-800-418-FORM 1-800-418-3676	1-888-CALL-FCC 1-888-225-5322 Or: <a href="http://www.fcc.gov">http://www.fcc.gov</a>

Before filling out your application, you must decide which frequency(ies) you can operate on. See “Frequencies and Code Charts”. For questions on determining the radio frequency, call Motorola Product Services at:

**1-800-448-6686**

Changes or modifications not expressly approved by Motorola may void the user's authority granted by the FCC to operate this radio and should not be made. To comply with FCC requirements, transmitter adjustments should be made only by or under the supervision of a person certified as technically qualified to perform transmitter maintenance and repairs in the private land mobile and fixed services as certified by an organization representative of the user of those services.

Replacement of any transmitter component (crystal, semiconductor, etc.) not authorized by the FCC equipment authorization for this radio could violate FCC rules.

Use of this radio outside the country where it was intended to be distributed is subject to government regulations and may be prohibited.

# RADIO OVERVIEW

## PARTS OF THE RADIO

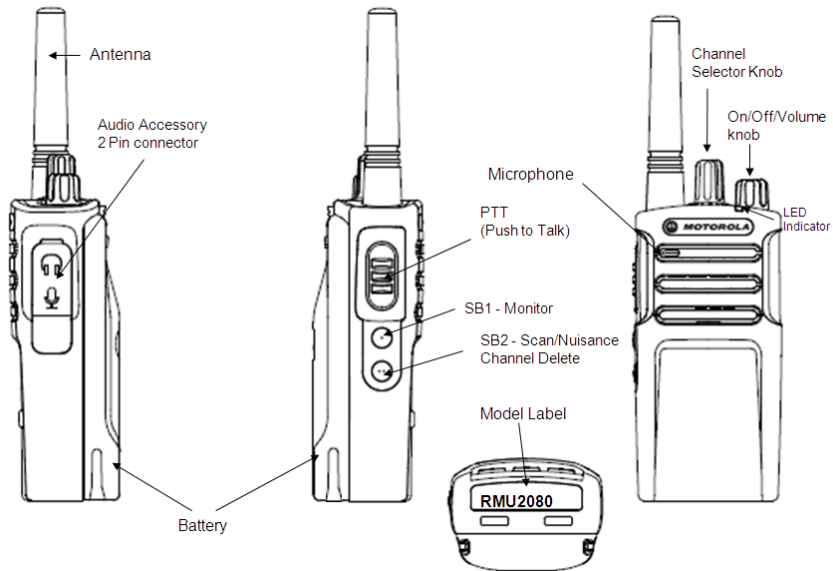

**On/Off/Volume Knob**

Used to turn the radio ON or OFF and to adjust the radio's volume.

**Channel Selector Knob**

Used to switch the radio to different channels.

**Accessory Connector**

Used to connect compatible audio accessories.

**Model Label**

Indicates the model of the radio.

**Microphone**

Speak clearly into the microphone when sending a message.

**Antenna**

For models **RMU2080**, and **RMV2080** the antennas are non-removable.

**LED Indicator**

Used to give battery status, power-up status, radio call information and scan status.

**Side Buttons*****Push-to-Talk (PTT) Button***

- Press and hold down this button to talk, release to listen it.

***Side Button 1 (SB1)***

- The Side Button 1 is a general button that can be configured by the Computer Programming Software - CPS. The default setting of SB1 is 'Monitor'.

***Side Button 2 (SB2)***

- The Side Button 2 is a general button that can be configured by the CPS. The SB2 default setting is 'Scan/Nuisance Channel Delete'.

**The Lithium-Ion (Li-Ion) Battery**

RM Series radios include a standard capacity battery. Other batteries may be available. For more information, see "Battery Features" on page 14.

This User Guide covers multiple RM Series models, and may detail some features your radio does not have. The radio's model is shown at the bottom of the radio.

<b>Model</b>	<b>Frequency Band</b>	<b>Transmit Power (Watts)</b>	<b>Number of Channels</b>	<b>Antenna</b>
RMV2080	VHF	2	8	Non-removable
RMU2080	UHF	2	8	Non-removable

## BATTERY FEATURES

RM Series radios provide Lithium-Ion batteries that come in different capacities that will define the battery life.

### About the Li-Ion Battery

The RM Series radio comes equipped with a rechargeable Li-Ion battery. This battery should be charged before initial use to ensure optimum capacity and performance.

Battery life is determined by several factors. Among the more critical are the regular overcharge of batteries and the average depth of discharge with each cycle. Typically, the greater the overcharge and the deeper the average discharge, the fewer cycles a battery will last. For example, a battery which is overcharged and discharged 100% several times a day, lasts fewer cycles than a battery that receives less of an overcharge and is discharged to 50% per day. Further, a battery

which receives minimal overcharging and averages only 25% discharge, lasts even longer.

Motorola batteries are designed specifically to be used with a Motorola charger and vice versa. Charging in non-Motorola equipment may lead to battery damage and void the battery warranty. The battery should be at about 77°F (25°C) (room temperature), whenever possible. Charging a cold battery (below 50° F [10°C]) may result in leakage of electrolyte and ultimately in failure of the battery. Charging a hot battery (above 95°F [35°C]) results in reduced discharge capacity, affecting the performance of the radio. Motorola rapid-rate battery chargers contain a temperature-sensing circuit to ensure that batteries are charged within the temperature limits stated above.



## **Battery Recycling and Disposal**

Li-Ion rechargeable batteries can be recycled. However, recycling facilities may not be available in all areas. Under various U.S. state laws and the laws of several other countries, batteries must be recycled and cannot be disposed of in landfills or incinerators. Contact your local waste management agency for specific requirements and information in your area. Motorola fully endorses and encourages the recycling of Li-Ion batteries. In the U.S. and Canada, Motorola participates in the nationwide Rechargeable Battery Recycling Corporation (RBRC) program for Li-Ion battery collection and recycling.

Many retailers and dealers participate in this program. For the location of the drop-off facility closest to you, access RBRC's Internet web site at:

**[www.rbrc.com](http://www.rbrc.com)**

or call:

**1-800-8-BATTERY**

This internet site and telephone number also provides other useful information concerning recycling options for consumers, businesses and governmental agencies.

## Installing the Lithium-Ion (Li-Ion) Battery

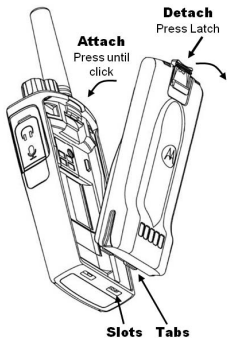

1. Turn OFF the radio.
2. With the Motorola logo side up on the battery pack, fit the tabs at the bottom of the battery into the slots at the bottom of the radio's body.
3. Press the top part of the battery towards the radio until a click is heard.

**Note:** To learn about the Li-Ion Battery Life features, refer to "About the Li-Ion Battery" on page 14

## Removing the Lithium-Ion (Li-Ion) Battery

1. Turn OFF the radio.
2. Push down the battery latch and hold it while removing the battery.
3. Pull the battery away from the radio.

## Holster

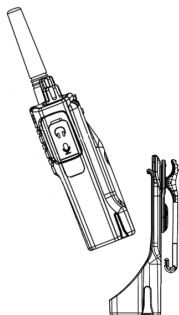

1. Slide the radio into the base of the holster and then press the radio against the back of the holster until the top clips are inserted in the top latches of the battery.
2. To remove, detach the top clips of the holster from the top latches of the battery and then slide the radio up from the holster pocket.

## Power Supply and Drop-in Tray Charger

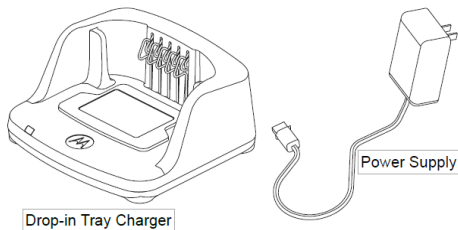

The radio is equipped with one Drop-in Tray Charger and one Power Supply with Adaptor. For details, see “Chargers” on page 72.

## Battery Life Information

When the Battery Save feature is ON (enabled by default) the battery life will be longer. The following chart summarizes battery life estimations:

Li-Ion battery Life with Tx Power 2 Watts		
Battery Type	Battery Save Off	Battery Save On
Standard	12 hrs.	15 hrs.
High capacity	N/A Yet	N/A Yet

**Note:** Battery life is estimated based on 5% transmit/ 5% receive/ 90% standby standard duty cycle

## Charging the Battery

The RM series radios offers two types of power supply:

- Standard Power Supply and,
- Rapid Power Supply .

**Note:** The radio comes equipped with a Standard Power Supply

To charge the battery (with the radio attached), place it in a Motorola-approved Drop-in Tray Single Unit Charger or Drop-in Tray Multi Unit Charger.

**Note:** For part number details, refer to “Chargers” on page 72

## Charging with the Drop-in Tray Single Unit Charger (SUC)

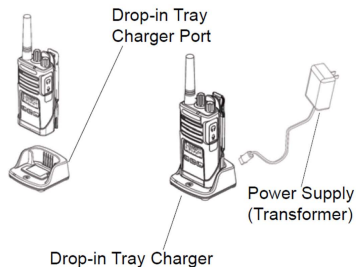

1. Place the drop-in tray charger on a flat surface.
2. Insert the connector of the power supply into the port on the back of the drop-in tray charger.
3. Plug the AC adaptor into a power outlet.
4. Insert the radio into the tray with the front of the radio facing the front of the charger, as shown.

**Note:** When charging a battery attached to a radio, turn the radio OFF to ensure a full charge. See “Operational Safety Guidelines” on page 9 for more information



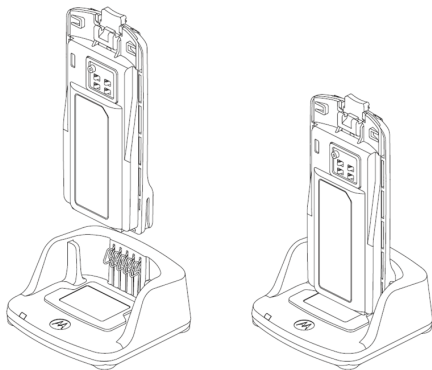





## CHARGING A STAND-ALONE BATTERY



To charge only the battery - at step 4, insert the battery into the tray, with the inside surface of the battery facing the front of the charger, as shown. Ensure the slots in the battery correctly engage in the charger

## Drop-in Tray Charger LED Indicators

Table 2: Charger LED Indicator

Status	LED Status	Comments
Power On	Green for approx. 1 sec 	
Charging	Steady red 	
Charge Complete	Steady green 	
Battery Fault (*)	Red fast flash 	
Waiting to charge (**)	Amber slow flash 	
Battery Level Status	NA	Battery empty
	Flash red 1 time 	Battery low
	Flash amber 2 times 	Battery medium
	Flash green 3 times 	Battery high

(\*) Normally, re-positioning the battery pack will correct this issue.

(\*\*) Battery temperature is too warm or too cold or wrong power voltage is being used.

If there is NO LED indication:

1. Check if the radio with battery, or the battery alone, is inserted correctly (refer to step 3 of "Charging Procedure").
2. Make sure the power cord is securely plugged into the charger and an appropriate AC outlet and that there is power to the outlet.
3. Confirm that the battery being used with the radio is listed in Table 1.

Part No.	Description
<b>PMNN4434_R</b>	<b>Standard Li-Ion Battery</b>
<b>PMNN4453_R</b>	<b>High Cap. Li-Ion Battery</b>

Table 1

## ***Estimated Charging Time***

The following table provides the estimated charging time of the battery. For further details, see “Battery” on page 80.

<b>Charging solutions</b>	<b>Estimated Charging time - Hours</b>	
	<b>Standard Battery</b>	<b>High Cap. Battery</b>
<b>Standard</b>	<b>≤ 4.5</b>	<b>N/A yet</b>
<b>Rapid</b>	<b>≤ 2.5</b>	<b>N/A yet</b>



## Charging a Radio and Battery using a Multi Unit Charger- MUC (Optional Accessory)

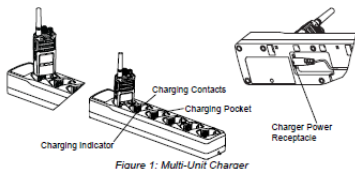

Figure 1: Multi-Unit Charger

The Multi Unit Charger (MUC) allows drop-in charging of up to 6 radios or batteries. Batteries can be charged with the radios or removed and placed in the MUC separately. Each of the 6 charging pockets can hold a radio (with or without holster) or battery, but not both.

1. Insert the power cord plug into the MUC's jack.
2. Place the charger on a flat surface.
3. Plug the cord into an AC outlet.
4. Turn the radio OFF.
5. Insert the radio or battery into the charging pocket.

### Notes:

- This Multi Unit Charger also allows you to clone up to 2 radios (2 Source radios and 2 Target radios). Refer to page 51 for details.
- Further details on MUC's operation are explained in the Instructions Sheet provided with the MUC. For part number details, refer to the Accessories section.

Table 2: Charger LED Indicator

Status	LED Status	Comments	
Power On	Green for approx. 1 sec	●	
Charging	Steady red	●	
Charge Complete	Steady green	●	
Battery Fault (*)	Red fast flash	⚡	
Waiting to charge (**)	Amber slow flash	⚡	
Battery Level Status	NA	Battery empty	
	Flash red 1 time	⚡	Battery low
	Flash amber 2 times	⚡	Battery medium
	Flash green 3 times	⚡	Battery high

(\*) Normally, re-positioning the battery pack will correct this issue.

(\*\*) Battery temperature is too warm or too cold or wrong power voltage is being used.

If there is NO LED indication:

1. Check if the radio with battery, or the battery alone, is inserted correctly (refer to step 3 of "Charging Procedure").
2. Make sure the power cord is securely plugged into the charger and an appropriate AC outlet and that there is power to the outlet.
3. Confirm that the battery being used with the radio is listed in Table 1.

Part No.	Description
PMNN4434_R	Standard Li-Ion Battery
PMNN4453_R	High Cap. Li-Ion Battery

Table 1

## GETTING STARTED

For the following explanations, refer to “Parts of the Radio” on page 8.

### TURNING RADIO ON/OFF

To turn the radio **ON**, rotate the ON/OFF/Volume Knob clockwise. The radio will play either one of the following options:

- Power up tone and channel number announcement
- Battery level and channel number announcement
- Silent

The LED blinks red briefly.

To turn the radio **OFF**, rotate the On/Off/Volume Knob counterclockwise until you hear a ‘click’ and the radio LED Indicator turns **OFF**.

### ADJUSTING VOLUME

Turn the On/Off/Volume Knob clockwise to increase the volume, or counterclockwise to decrease the volume.

**Note:** Do not hold the radio too close to the ear when the volume is high or when adjusting the volume

## SELECTING A CHANNEL

To select a channel, rotate the Channel Selector Knob and select the desired channel number.

Each channel has its own Frequency, Interference Eliminator Code and Scan Settings.

## TALKING AND MONITORING

It is important to monitor for traffic before transmitting to avoid ‘talking over’ someone who is already transmitting.

To monitor, long press and hold the SB1(\*) button to access channel traffic. If no activity is present, you will hear ‘static’. To release, press SB1 again. Once channel traffic has cleared, proceed with your call by pressing the PTT button. When transmitting, the LED Indicator will be On solid red during transmission.

**Notes:**

- To listen to all activity on a current channel, short press the SB1 to set the CTCSS/DPL code to 0. This feature is called 'CTCSS/DPL Defeat (Squelch set to SILENT)'.
- (\* This assumes SB1 is not being programmed for a different mode.

**RECEIVING A CALL**

Select a channel by rotating the Channel Selector Knob until you reach the desired channel. Voice announcement will indicate the channel selected.

1. Make sure the PTT button is released and listen for voice activity.
2. The LED Indicator will be solid Red while the radio is receiving a call.
3. To respond, hold the radio vertically 1 to 2 inches (2.5 to 5cm) from mouth. Press the PTT button to talk; release it to listen.

**TALK RANGE**

<b>TALK RANGE</b>		
<b>Model</b>	<b>Industrial</b>	<b>Multi-Level</b>
	<b>Inside steel/concrete Industrial buildings</b>	<b>Inside multi-level buildings</b>
UHF 2W	Up to 250,000 Sq. Ft.	Up to 20 Floors
VHF 2W	Up to 220,000 Sq. Ft.	Up to 13 Floors

To establish a proper two-way communication, the channel, frequency, and interference eliminator codes must be the same on both radios. This depends on the stored profile that has been preprogrammed on the radio:

1. **Channel:** Current channel that the radio is using, depending on radio model.
2. **Frequency:** The frequency the radio uses to transmit/receive.
3. **Interference Eliminator Code:** These codes help minimize interference by providing a choice of code combinations.

4. **Scramble Code:** Codes that make the transmissions sound garbled to anyone listening who is not set to that specific code.

For details on how to set up frequencies and CTCSS/DPL codes in the channels, refer to “Advanced Configuration Mode” in page 36.

## RADIO LED INDICATORS

<b>Radio Status</b>	<b>Led Indication</b>
Channel Alias Edit	Red heartbeat (Models with Display only)
Channel Busy	Solid orange
Cloning Mode	Two orange heartbeats
Cloning In Progress	Solid orange
Fatal Error at Power up	One green blink, one orange blink, one green blink, then repeat for 4 seconds
Low Battery	Orange heartbeat
Low Battery Shutdown	Fast Orange heartbeat
Monitor	LED is OFF
Power-Up	Solid red for 2 seconds
Programming Mode	Green heartbeat
Scan Mode	Fast Red heartbeat
Transmit (Tx)/Receive (RX)	Solid red
Transmit in Low Power Select	Solid Orange (Not available for XT Series)
Vox/iVox mode	Double red heartbeats

## HANDS-FREE USE/VOX

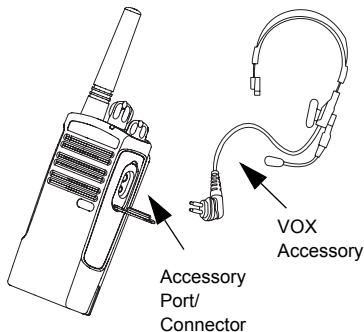

Motorola RM Series radios can operate hands-free (VOX) when used with compatible VOX accessories.

### With Compatible VOX Accessories

The default factory setting for VOX sensitivity level is OFF. Before using VOX, set VOX level to a setting different from 'OFF' via the CPS (Customer Programming Software). Then, perform the following steps:

1. Turn the radio OFF.
2. Open accessory cover.
3. Insert the audio accessory's plug firmly into accessory port.
4. Turn radio ON. The LED Indicator will blink double red.
5. Lower radio volume BEFORE placing accessory near ear.
6. To transmit, speak into accessory microphone and to receive, stop talking.

**Note:** To order accessories, refer to: [www.motorolasolutions.com](http://www.motorolasolutions.com), call 1 (800) 448-6686, or contact your Motorola point of purchase

## Setting VOX Sensitivity

The sensitivity of the radio's accessory or microphone can be adjusted to suit different operating environments. VOX sensitivity can be programmed via the CPS.

Default value is OFF . If you want to use the VOX feature, VOX level should be set at a value different from OFF.

- 1 = High audio input level will trigger the Tx
- 2 = Medium sensitivity
- 3 = Low audio input level will trigger the Tx

## Microphone Gain

The sensitivity of the microphone can be adjusted to fit different users or operating environments.

This feature can be adjusted only through the CPS. Microphone default setting is set to 2 = Medium Gain.

## Hands Free without Accessories (iVOX)

- Enable iVOX by pressing the PTT button while turning the radio ON.
- iVOX operation can be temporarily disabled by pressing the PTT button.
- A short press of the PTT button will re-enable iVOX.
- There is a short delay between when you start talking and when the radio transmits.

### **Toggle Voice Prompt in User Mode**

Short press the SB1 button while turning ON the radio to enable/disable Voice Prompt in User mode (Default is set to ON).

**Note:** This setting is set to OFF by default

### **Power Up - Tone Mode**

Toggle power up mode, To enable/disable press SB1 and SB2 buttons simultaneously for 2 or 3 seconds while powering up the radio until you hear a quick series of beeps and the power up voice announcement programmed.

### **Reset to Factory Defaults**

Reset to Factory Defaults will set back all radio features to the original factory default settings. To do so, press PTT, SB2 and SB1 simultaneously while turning ON the radio until you hear a high tone chirp.



## PROGRAMMING FEATURES

To easily program all the features in your radio, it is recommended to use the Customer Programming Software (CPS) and programming cable.

CPS software download is available for free at [www.motorolasolutions.com/RMseries](http://www.motorolasolutions.com/RMseries)

### Advanced Configuration

Advanced Configuration is a configuration mode that allows the customization of additional features via the front panel.

The non-display models don't have a display to show programmed values, then navigation is guided via voice prompt.

When the radio is set to Advanced Configuration, you are able to read and modify four features:

- Frequency Selection
- CTCSS/DPL Codes
- Auto-Scan.
- Active Channels
- Enable/Disable/Program the Weather Channel

The Frequency Select feature allows you to choose frequencies from a pre-defined list.

The Interference Eliminator Code (CTCSS/DPL) helps minimize interference by providing you with a choice of code combinations that filter out static, noise, and unwanted messages.

The Auto-Scan feature allows you to set a particular channel to automatically enable Scan each time you switch to that channel.

The Active Channels feature allows you to increase or decrease the amount of channels active (In the range of maximum channels).

The Weather Programming feature allows to alternate the channel function, between 2 way radio channel and weather channel. Also for weather channel function allows to chose one of the 7 received frequencies.

### Entering Advanced Configuration Mode

**Note:** Before programming the features, make sure your radio is set to the channel you wish to program. You can do so before entering Advanced Configuration Mode or at any time during the Advanced Configuration Mode by rotating the Channel Selector Knob.

To read or modify Frequencies, Codes, Auto-Scan, Active Channels or enable/disable the Weather Channel, set the radio to 'Advanced Configuration Mode' by pressing and holding the PTT and SB1 buttons simultaneously for 3 to 5 seconds while powering up the radio and until you hear a voice prompt saying "Programming Mode" and "Channel #".

**Note:** 'Idle' Programming Mode is the stage of the Programming Mode in which the radio is waiting for the user to start the radio programming cycle.

Once you are in the 'Idle' Programming Mode, you will be able to hear the Frequencies, Codes, Auto-Scan, active channels settings and Weather Channel enable/disable by short pressing the PTT button to move along the different programmable features.

### Entering Frequencies Values

RM Series radios have 99 frequencies for UHF and 27 for VHF.

Once in 'Idle' Programming Mode, the first value available to change is Channel number, you can change the channel by rotating the Channel Selector Knob, voice announcement will indicate channel selected. Using SB1 and SB2 you can change values. The value selected is announced by voice prompt.

## Reading CTCSS/DPL Values

If you continue short pressing the PTT button the radio will move forward to programming CTCSS/PL Codes.

After hearing the current value for CTCSS/PL Code you can scroll to a new code value using the SB1 or SB2 button.

RM Series have up to 219 codes available (refer to “Frequencies and Codes Charts” Section).

## Reading Auto-Scan Values

After hearing the CTCSS/DPL codes, short press the PTT button and the radio will move forward to programming Auto-Scan.

Auto-Scan only has two values:

- Enabled
- Disabled

If you continue short pressing the PTT button the radio will move forward to programming

## Active Channels.

Again, another short pressing the PTT, the radio will advance to enable/disable

## Weather Channels.

## Saving Settings

If you are satisfied with the setting, you can either:

- short press PTT to continue programming,
- long press PTT to save and return to 'Idle' Programming Mode, or
- return to normal radio operation if the radio is already in idle mode or
- long press the PTT button twice to exit 'Idle' Programming Mode and return to the normal radio operation.

### Note:

- If you do not wish to save the value you just programmed, turn the radio OFF or switch the Freq knob before radio entering idle mode
- If long PTT press or radio return to "Idle" Programming mode, radio will save the changes.
- If you 'roll-over' to the beginning of 'Idle' Programming Mode you will hear "Channel #" and the LED Indicator will show a green heartbeat again. All values that were changed will be automatically saved.

## Programming Mode FAQ

1. *I got distracted while programming and forgot which feature I was programming. What should I do?*

Return to 'Idle' Programming Mode and start over.

- Long press the PTT button. The radio will return to the 'Idle' Programming Mode or,
- Turn OFF the radio and enter Programming Mode again (see instructions in the beginning of this section)

2. *I am trying to program a frequency (or code) value but the radio would not do it. It rolled over and took me back to value '0'.*

The radio will not allow you to program any values that are not available in the frequencies and codes pool. For example, if you try to program code 220, the radio would not accept it, as the maximum value allowed is 219. Same thing will happen with frequencies. Check the Frequencies and Codes Charts section to make sure you are programming a valid number.

3. *I am trying to enter the Programming Mode but the radio would not do it.*

The radio might be locked using the CPS to not allow Front Panel Programming. To re-enable, use the CPS.

4. *When I was programming I made a mistake and programmed the wrong value. How can I erase it or re-program it?*

If you make a mistake while programming a value you have two choices:

- The radio settings will roll-over each time they reach a maximum or minimum value. Keep increasing (short press SB1) or decreasing (short pressing SB2) until you get the desired value or,
- Turn OFF the radio and start-over.

5. *I just programmed the value I wanted. How do I exit Programming Mode?*

- If you are in Programming Mode you can exit by long pressing the PTT button twice.
- If you are already in the 'Idle' Programming Mode, long press the PTT button once.

6. *I am done programming the features in this channel and want to program another channel.*

Press short PTT several times until you hear "Channel #", then switch channel using Channel Selector Knob. If you wish to save the changes, make sure you are in the 'Idle' Programming Mode before switching the channel as otherwise you will lose the changes made.

## PROGRAMMING VALUES EXAMPLE

### Example of Programming a Frequency

Assuming current frequency value is set to Channel 1, with the UHF default frequency '02' (equivalent to 464.5500 MHz), and you want to change it to Frequency Number = '13' (which is mapped to 461.1375 MHz), follow this sequence:

- Enter into Advanced Configuration Mode

- Short press the PTT button to enter Frequency Programming Selection Mode. Radio will announce current value '2'
- Press SB1 button eleven times to scroll up the frequency list and you will hear frequency "13"
- Long press the PTT button. LED Indicator will show a heartbeat to indicate 'Idle' state.
- Long press the PTT button to exit Programming Mode or turn radio OFF.

### Example of Programming a Code

Assuming current code value is set to factory default '001', and you want to change it to CTCSS/DPL Code = 103 follow the sequence below:

- Enter into Advanced Configuration Mode
- Short press the PTT button twice and you will hear "Code #" (Entering CTCSS/DPL Programming Selection Mode).
- Press and hold SB1 or SB2 will cause the radio to increment by 10's - 10, 20, 30 ... 100, 110. Will not hear 103. Need to release SB1 or SB2, then slowly press/release SB1 or SB2 until the user reaches the desired code, in this case "103"
- Long press the PTT button. LED Indicator will show a green heartbeat to indicate 'Programming' state.
- Long press the PTT button to exit Programming Mode or turn radio OFF.

**Example of Programming Auto-Scan** Auto-Scan is the third Programming Mode and can be set to either ON or OFF on a particular channel.

To set Auto-Scan to ON:

- Enter into advanced Configuration Mode and select the desired channel.
- Short press the PTT button three times to enter Auto-Scan Programming Selection Mode. The radio will announce "Auto-Scan" and current setting (Enabled or Disabled), followed by changing instruction - "To change, press side button 1 or 2"

### **Example of Programming Active Channels**

Active Channels allows you to modify the . of active channels the radio will be programmed to support.

To set Active Channels:

- Enter Programming Mode and select the desired channel.
- Short press the PTT button Four times to enter Active Channels Programming Selection Mode.
- The radio will announces "Active Channels" and current value followed by changing instruction.

- Short press the SB1 or SB2 buttons until you hear the number of channels desired.
- Long press the PTT button. LED Indicator will show a green heartbeat to indicate Idle/ Programming state.
- Long press the PTT button to exit Programming Mode or turn radio OFF.

### **Example of Programming Weather Channels**

Weather Channels mode allows you toggle a radio channel between 2 way radio mode and weather alert mode.

To set Channels to Weather mode:

- Enter Programming Mode and select the desired channel.
- Short press the PTT button five times to enter Weather Channels Programming Mode.
- The radio will announce "Weather Channel and Frequency used" plus how to change it.
- Short press the SB1 or SB2 to enable/disableLong press the PTT button.
- LED Indicator will show a green heartbeat to indicate Programming state.
  - Long press the PTT button to exit Programming Mode or turn radio OFF.

## OTHER PROGRAMMING FEATURES

### Scan

Scan allows you to monitor other channels to detect conversations. When the radio detects a transmission, it will stop scanning and will receive on the active channel. This will allow you to listen and talk to people on that channel without having to change channel. If there is are transmissions on another channel once the radio has stopped scanning then you will not hear that activity. After activity has ceased on the channel which the radio has stopped, scanning will resume again after 5 seconds of no activity on that channel.

- To start scanning, press the SBx (x=1 or 2) button (Scan is defaulted on SB2 but can be programmed to either SB1 or SB2 via CPS). When the radio detects channel activity, it will stop on that channel until the activity ends. You can respond to the caller on that channel without having to switch channels by pressing PTT.

- To stop scanning, short press the SBx button again.
- By pressing the PTT button while the radio is scanning, the radio will transmit on the channel which was selected before Scan was activated. If no transmission occurs within five seconds, scanning will resume.
- If you want to scan a channel without Interference Eliminator Codes (CTCSS/DPL), set the code settings for the channels to '0' in the CTCSS/DPL Programming Selection Mode.

Whenever the radio is set up in Scan, the LED Indicator will signal a Fast Red Heartbeat.



## Editing Scan List

Scan Lists can be edited by using the CPS (refer to CPS section on page 46)

### Nuisance Channel Delete

Nuisance Channel Delete allows you to temporarily remove channels from the Scan List. This feature is useful when frequent, irrelevant conversations on a channel tie up the scanning feature, becoming a nuisance to the user.

To delete a channel from the Scan List:

- To start scanning, press the SBx (x=1 or x=2) button (Scan has to be programmed to either SB1 or SB2 via CPS). SB2 by default programmed to Scan/Nuisance Channel Delete
- Wait until the radio stops on the channel you wish to eliminate, then long press the SBx button to delete it. (Cannot delete home channel - the channel that the user enables scan on).
- The channel will not be scanned again until you exit Scan by short pressing the SBx button again or by turning the radio OFF and back ON.

## CPS (COMPUTER PROGRAMMING SOFTWARE)

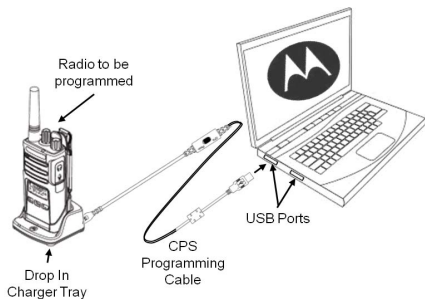

The easiest way to program or change features in your radio is by using the Computer Programming Software (CPS) and the CPS Programming Cable(\*). CPS Software is available for free as web based downloadable software at:

**[www.motorolasolutions.com/RMseries](http://www.motorolasolutions.com/RMseries)**

To program, connect the RM Series radio via the Drop-in Charger Tray and CPS Programming Cable as shown in the picture above. (Need to select CPS mode on the cable switch).

CPS allows the user to program frequencies, PL/DPL codes, as well as other features such as: Bandwidth Select, Time-out Timer, Power Select, Scan List, Call Tones, Scramble, Reverse Burst, etc. CPS is a very useful tool as it can also lock the Front-Panel Radio Programming to avoid accidentally erasing the current radio settings. It also provides security by giving the option to set up a password for radio profile management. Please refer to Features Summary Chart Section at the end of the user guide for more details.

**Note:** (\*) CPS Programming Cable P/N HKKN4027A is an accessory sold separately. Please contact your Motorola point of purchase for more information.

## Time-Out Timer

This timer sets the amount of time that the radio can continuously transmit before transmission is automatically terminated. The default setting is 60 seconds and can be changed using the CPS.

## Power Select

Power Select allows you to select between high and low transmission power per channel. The power levels for RM Series toggle between 2W and 1W.

## Call Tones

Call Tones feature allows you to transmit an audible tone to other radios on the same channel and alerting them that you are about to talk or alerting them without speaking. The call tones feature must be programmed to SB1 or SB2 and 1 of 3 pre-recorded tones selected

## Scramble

The Scramble feature makes transmissions sound garbled to anyone listening without the same code. Scramble default value is OFF. The Scramble feature should be programmed to SB1 or SB2, If the scramble code need to be changed during radio's normal operation.

## Reverse Burst

Reverse Burst eliminates unwanted noise (squelch tail) during loss of carrier detection. You can select values of either 180 or 240 to be compatible with other radios. Default is 180.

### Notes:

- The features described in previous pages are just some of the features CPS has. CPS offers more capabilities. For more information refer to the HELP file in the CPS.
- Some of the features available with the CPS software may vary depending on the radio model.

# Weather Channel

**NOAA Weather Radio All Hazards** (NWR) is a nationwide network of radio stations broadcasting continuous weather information directly from the nearest [National Weather Service office](#). NWR broadcasts official Weather Service warnings, watches, forecasts and other hazard information 24 hours a day, 7 days a week.

Working with the [Federal Communication Commission's](#) (FCC) [Emergency Alert System](#), NWR is an "All Hazards" radio network, making it your single source for comprehensive weather and emergency information. In conjunction with Federal, State, and Local Emergency Managers and other public officials, NWR also broadcasts warning and post-event information for all types of hazards – including natural (such as earthquakes or avalanches), environmental (such as chemical releases or oil spills), and public safety (such as AMBER alerts or 911 Telephone outages).

Known as the "Voice of NOAA's National Weather Service," NWR is provided as a public service by the [National Oceanic and Atmospheric Administration](#) (NOAA), part of the Department of Commerce. NWR includes [1000 transmitters](#), covering all 50 states, adjacent coastal waters, Puerto Rico, the U.S. Virgin Islands, and the U.S. Pacific Territories. NWR requires a [special radio receiver](#) or scanner capable of picking up the signal. Broadcasts are found in the VHF public service band at these seven frequencies (MHz):

162.400

162.425

162.450

162.475

162.500

162.525

162.550

## Weather Channel (Cont.)

The channel position 8 on all RM Series radios with channel selector knob is configured at the factory as a NOAA Weather Radio.

The NOAA Weather Radio feature can be disabled or configured to any of the other available channel positions via the Customer Programming Software or in Advanced Configuration Mode. When a channel that has the NOAA Weather Radio enabled is selected, the RM radio generates a voice announcement indicating channel and weather frequency number, e.g. "Channel 8: Weather 1". The weather frequency number announced is which of the 7 NOAA national frequencies is currently tuned in the weather radio. The weather frequency can be changed while in the Weather Channel by Pressing SB2 to enter Weather menu then SB1 acts as up button and SB2 acts down button. Also, PTT acts as menu button to advance to channel menu or weather alert menu.

### **NOAA Weather Alert**

The RM Series radio is capable of monitoring the NOAA frequency for any Alerts issued by the National Weather Service. When the weather alert feature is enabled the radio will "mute" the daily weather radio, you can then move the channel position to a standard two way radio frequency and continue normal communication.

The Weather Alert allows the radio to "listen" for a Warning Alarm Tone (WAT) from the National Weather Service. If a WAT is detected the weather radio will "un-mute" and the message being broadcasted will be heard on the RM radio.

If the RM radio is tuned to a two-way channel (normal operation + weather alert on) when a WAT is detected, the radio will "un-mute" and the message being broadcasted will be heard. While monitoring an alert, pressing the PTT or changing channels will exit the weather alert and go back to normal operation.

Please note that using the Weather Alert feature will impact normal battery life.

## CLONING RADIOS

You can clone RM Series radio profiles from one Source radio to a Target radio by using any one of these 3 methods:

- Using a Multi Unit Charger (optional accessory),
- Two Single Unit Chargers (SUC) and a Radio-to-Radio cloning cable (optional accessory),
- the CPS (free software download) and CPS programming cable (optional accessory).

### Cloning with a Multi Unit Charger (MUC)

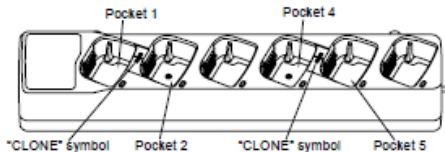

To clone radios using the MUC, there must be at least two radios:

- a Source radio (radio which profiles will be cloned

or copied from) and

- a Target radio (the radio which profile will be cloned from the source radio.)

The Source radio has to be in Pocket 1 or 4 while the Target radio has to be in Pocket 2 or 5, matching in the MUCs pockets by pairs as follows:

- 1 and 2 or,
- 4 and 5

When cloning, the MUC does not need to be plugged into a power source, but ALL radios require charged batteries.

1. Turn ON the Target radio and place it into one of the MUC Target Pockets
2. Power the Source radio following the sequence below:
  - Hold the PTT button and SB2 for 3 to 5 seconds simultaneously while turning the radio ON.

- Wait for 3 seconds before releasing the buttons until a distinctive audible tone is heard and 'Cloning' is announced.
3. Place the Source radio in the source pocket that pairs with the target pocket you chose in step 1. Short press SB1 on Source radio.
  4. After cloning is completed, the Source radio will announce either 'Successful' (cloning was successful) or 'failed' (cloning process has failed).
  5. Once you have completed the cloning process, turn the radios OFF and ON to exit the 'cloning' mode.

Further details on how to clone radios are explained in the Instructions Sheet provided with the MUC.

When ordering the MUC, please refer to P/N PMLN6384A.

## Notes

- If cloning fails please refer to "What To Do if Cloning Fails" on page 54.
- Paired Target radios and Source radios must be of the same band type in order for the cloning to run successfully.
- MUC pockets numbers should be read from left to right with the Motorola logo facing front.

## CPS and Cloning Cables (Optionals)

- Both **CPS** and **Cloning** cables are made to work either with RM Series radios or RDX series. Cloning cable also can work with a mix of RDX and RM radios.
- The CPS cable is made to program RM series radio when the switch is in either "Flash" or "CPS" position. If you want to use the CPS cable to program RDX radios, make sure the switch is in "CPS" position and attach a USB converter provided as part of the CPS cable kit.
- **Cloning** cable allows you to clone:
  - RM Series, make sure the switch is either in "Cloning" or "Legacy" position.
  - RDX radios, make sure the switch is in "Legacy" position there is one USB converter attached on each side.
  - RM and RDX radios, make sure the switch is in "Legacy" position and use a USB converter to connect to the RDX SUC.Cloning cable kit provides 1 USB converter.

### CPS Cable

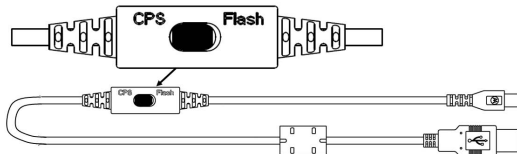

### Cloning Cable

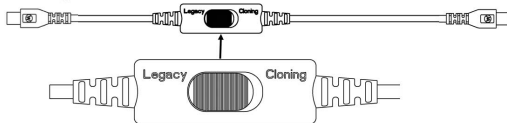

### USB Converter





## Cloning Radio using the Radio to Radio (R2R) Cloning Cable (Optional Accessory)

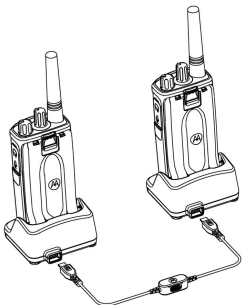

### Operating Instructions

1. Before beginning the cloning process, make sure you have:
    - A fully charged battery on each one of the radios.
    - Two Single Unit Chargers (SUC).  
Either 2 SUC for RM Series or 1 SUC for RM Series and 1 SUC for RDX Series
    - Turned OFF the radios and,
  2. Unplug any cables (power supply or USB cables) from the SUCs.
  3. Plug one side of the cloning cable mini connector to one SUC. Plug the other end to the second SUC.
- Note:** During the cloning process no power is being applied to the SUC. The batteries will not be charged. A data communication is being established between the two radios.
4. Turn ON the Target radio and place it into one of the SUCs.
  5. On the Source radio, power the radio following the sequence below:
    - Long press the PTT button and SB2 simultaneously while turning the radio ON.
    - Wait for 3 seconds before releasing the buttons until you hear a distinctive audible tone and the word "Cloning"
  6. Place the Source radio in its SUC, press and release SB1.

7. After cloning is completed, the Source radio will announce either 'Successful' (cloning was successful) or 'failed' (cloning process has failed).
8. Once you have completed the cloning process, turn the radios OFF and ON to exit 'clone' mode.
3. Ensure that the battery is engaged properly on to the radio.
4. Ensure that there is no debris in the charging tray or on the radio contacts.
5. Ensure that the Source radio is in cloning mode.
6. Ensure that the Target radio is turned ON.
7. Ensure that radios are both from the same frequency band, same region and same transmission power.

### ***What To Do if Cloning Fails***

The radio will emit "Fail" indicating that the cloning process has failed. In the event that cloning fails, try performing each of the following before trying to start the cloning process again:

1. Ensure that the batteries on both radios are fully charged.
2. Check the cloning cable connection on both SUCs.

**Note:** This cloning cable is designed to operate only with compatible Motorola SUC RLN6175 and PMLN6394A

When ordering Cloning Cable please refer to P/N HKKN4028A. For details about accessories refer to Accessories section.

## Cloning using the CPS (Computer Programming Software)

When cloning using this method, you will need to have the CPS software, a Drop-in Tray Charger and the CPS Programming Cable.

To order the CPS Programming Cable, please refer to HKKN4028A

Information on how to clone using the CPS is available either in:

- the CPS Help File --> Content and Index --> Cloning Radios, or
- in the CPS Programming Cable Accessory Leaflet.

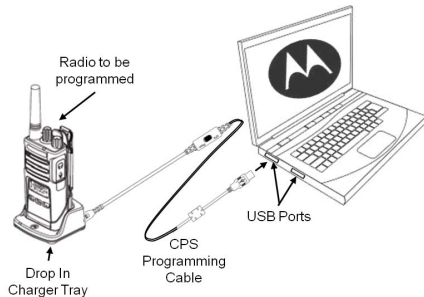

# TROUBLESHOOTING

<i>Symptom</i>	<i>Try This...</i>
No Power	Replace the battery. Extreme operating temperatures may affect battery life. Refer to See "About the Li-Ion Battery" on page 14.
Hearing other noises or conversation on a channel	Confirm Interference Eliminator Code is set. Frequency or Interference Eliminator Code may be in use. Change settings: either change frequencies or codes on all radios. Make sure radio is at the right frequency and code when transmitting. Refer to "Talking and Monitoring" on page 24.
Message Scrambled	Scramble Code might be ON, and/or setting does not match the other radios' settings.
Audio quality not good enough	Radio settings might not be matching up correctly. Double check frequency codes to make sure they are identical in all radios

## Symptom

Limited talk range	<p>Check for clear line of sight to improve transmission.</p> <p>Wearing radio close to body such as in a pocket or on a belt decreases range. Change location of radio. To increase range and coverage, you can reduce obstructions, increase power. UHF radios provides greater coverage in industrial and commercial buildings. Increasing power provides greater signal range and increased penetration through obstructions.</p> <p>Refer to See “Talking and Monitoring” on page 24.</p>
Message not transmitted or received	<p>Make sure the PTT button is completely pressed when transmitting.</p> <p>Confirm that the radios have the same Channel, Frequency, Interference Eliminator Code and Scramble Code settings. Refer to “Talking and Monitoring” section on page 24 for further information.</p> <p>Recharge, replace and/or reposition batteries. Refer to “About your Li-Ion Battery” section on page 11.</p> <p>Obstructions and operating indoors, or in vehicles, may interfere. Change location. Refer to “Talking and Monitoring” Section on page 24.</p> <p>Verify that the radio is not in Scan. Refer to “Scan” on page 41 and “Nuisance Channel Delete” on page 41.</p>

<b>Symptom</b>	<b>Try This...</b>
Heavy static or interference	Radios are too close; they must be at least five feet apart. Radios are too far apart or obstacles are interfering with transmission. Refer to "Talking and Monitoring" on page 24.
Low batteries	Recharge or replace Li-Ion battery. Extreme operating temperatures affect battery life. Refer to "About the Li-Ion Battery" on page 11.
Drop-in Charger LED light does not blink	Refer to "Charging the Battery" section on page 21, "Drop-in Tray Charger LED Indicators" section on page 24 and "Installing the Lithium-Ion Battery" section on page 13.
Low battery indicator is blinking although new batteries are inserted	Refer to "Installing the Li-Ion Battery" section on page 13 and "About your Li-Ion Battery" section on page 11.

## Symptom

Cannot activate VOX	VOX feature might be set to OFF. Use the CPS to ensure that the VOX Sensitivity level is not set to 'Off'. Accessory not working or not compatible. Refer to "Hands-Free Use/VOX" section on page 28.
Battery does not charge although it has been placed in the drop-in charger for a while	Check drop-in tray charger is properly connected and correspond to a compatible power supply. Refer to "Charging with the Drop-In Tray Single Unit Charger" section on page 21 and "Charging a Standalone Battery" section on page 22. Refer to "Drop-in Tray Charger LED Indicators" section on page 24. Check the charger's LEDs indicators to see if the battery has a problem. Refer to "Drop-in Tray Charger LED Indicators" section on page 18.

**Note:** Whenever a feature in the radio seems to not correspond to the default or preprogrammed values, check to see if the radio has been programmed using the CPS with a customized profile.

## USE AND CARE

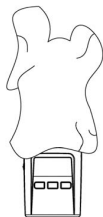

Use a soft damp cloth  
to clean the exterior



Do not immerse  
in water



Do not use alcohol or  
cleaning solutions

### If the radio is submerged in water...



Turn radio OFF and  
remove batteries

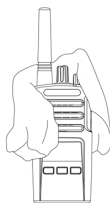

Dry with soft cloth



Do not use radio until  
completely dry



# FREQUENCY AND CODE CHARTS

## RM VHF FREQUENCIES CHART

The charts in this section provide Frequency and Code information. These charts are useful when using Motorola RM Series two-way radios with other business radios.

VHF Frequencies - BRUS					
Number	Frequency	Bandwidth	Number	Frequency	Bandwidth
1	151.6250	12.5	15	151.7750	12.5
2	151.9350	12.5	16	151.8650	12.5
3	152.8850	12.5	17	151.8950	12.5
4	152.9150	12.5	18	151.9250	12.5
5	151.7000	12.5	19	152.9000	12.5
6	151.7600	12.5	20	154.4900	12.5
7	152.9450	12.5	21	154.5150	12.5
8	151.8350	12.5	22	154.5275	12.5
9	151.8050	12.5	23	154.5400	12.5
10	151.5125	12.5	24	153.0050	12.5
11	151.6550	12.5	25	154.5475	12.5
12	151.6850	12.5	26	158.4000	12.5
13	151.7150	12.5	27	158.4075	12.5
14	151.7450	12.5			

In blue default frequencies

## ***RM VHF Frequencies (cont.)***

PLEASE NOTICE THAT THE FACTORY DEFAULT CONFIGURATION OF THE RM SERIES RADIOS HAVE BEEN MODIFIED TO BE IN COMPLIANCE WITH THE 2013 FCC NARROWBAND MANDATE. THIS MANDATE REQUIRES RADIO OPERATORS TO SWITCH THE CONFIGURATION OF THEIR EQUIPMENT TO 12.5 KHZ CHANNEL BANDWIDTH BY JANUARY 1ST, 2013. THE RM SERIES RADIO CHANNEL BANDWIDTH DEFAULT HAS BEEN SET AT 12.5 KHZ.

IF THIS NEW RADIO IS AN ADDITION OR REPLACEMENT TO AN EXISTING GROUP OF RADIOS WITH 25 KHz SETTING (LEGACY FACTORY CONFIGURATION), ACTION MAY BE REQUIRED ON YOUR PART IN ORDER TO OPTIMIZE OPERATION OF YOUR FLEET AND BE IN COMPLIANCE WITH FCC RULES.

TO CHANGE THE CHANNEL BANDWIDTH OF YOUR OLDER RDX RADIO FROM 25 KHZ TO 12.5 KHZ YOU MAY USE THE CUSTOMER PROGRAMMING SOFTWARE AVAILABLE FOR FREE DOWNLOAD AT HYPERLINK "<http://www.motorola.com/RDX>" [WWW.MOTOROLASOLUTIONS.COM/RDX](http://www.motorolasolutions.com/RDX) (PROGRAMMING CABLE REQUIRED) OR YOU CAN FOLLOW DIRECTIONS IN THE USER GUIDE UNDER 'PROGRAMMING FEATURES' .

IF YOU HAVE QUESTIONS OR NEED FURTHER ASSISTANCE, PLEASE CONTACT OUR CUSTOMER CARE TEAM AT +800-448-6686.

FOR ADDITIONAL DETAILS ON THE NARROWBAND MANDATE PLEASE VISIT [WWW.MOTOROLASOLUTIONS.COM/NARROWBANDING](http://WWW.MOTOROLASOLUTIONS.COM/NARROWBANDING)

## RMV2080 - VHF DEFAULT FREQUENCIES CHART

8 CH -RADIO VHF Defaults - BRUS				
Chan	Freq #	Frequency	Code	Bandwidth
1	20	154.4900	67.0 Hz	12.5 kHz
2	21	154.5150	67.0 Hz	12.5 kHz
3	1	151.6250	67.0 Hz	12.5 kHz
4	2	151.9550	67.0 Hz	12.5 kHz
5	10	151.5125	67.0 Hz	12.5 kHz
6	12	151.6850	67.0 Hz	12.5 kHz
7	15	151.7750	67.0 Hz	12.5 kHz
8	WC	162.4000	67.0 Hz	12.5 kHz

WC = Weather Channel Frequency

## RM UHF FREQUENCIES CHART

### *RM UHF Frequencies*

Frequency #	Frequency (MHz)	Bandwidth
1	464.5000	12.5 kHz
2	464.5500	12.5 kHz
3	467.7625	12.5 kHz
4	467.8125	12.5 kHz
5	467.8500	12.5 kHz
6	467.8750	12.5 kHz
7	467.9000	12.5 kHz
8	467.9250	12.5 kHz
9	461.0375	12.5 kHz
10	461.0625	12.5 kHz
11	461.0875	12.5 kHz
12	461.1125	12.5 kHz
13	461.1375	12.5 kHz

Frequency #	Frequency (MHz)	Bandwidth
14	461.1625	12.5 kHz
15	461.1875	12.5 kHz
16	461.2125	12.5 kHz
17	461.2375	12.5 kHz
18	461.2625	12.5 kHz
19	461.2875	12.5 kHz
20	461.3125	12.5 kHz
21	461.3375	12.5 kHz
22	461.3625	12.5 kHz
*23	462.7625	12.5 kHz
24	462.7875	12.5 kHz
25	462.8125	12.5 kHz
26	462.8375	12.5 kHz

### RM UHF Frequencies (Continued)

Frequency #	Frequency (MHz)	Bandwidth
27	462.8625	12.5 kHz
28	462.8875	12.5 kHz
29	462.9125	12.5 kHz
30	464.4875	12.5 kHz
31	464.5125	12.5 kHz
32	464.5375	12.5 kHz
33	464.5625	12.5 kHz
34	466.0375	12.5 kHz
35	466.0625	12.5 kHz
36	466.0875	12.5 kHz
37	466.1125	12.5 kHz

Frequency #	Frequency (MHz)	Bandwidth
38	466.1375	12.5 kHz
39	466.1625	12.5 kHz
40	466.1875	12.5 kHz
41	466.2125	12.5 kHz
42	466.2375	12.5 kHz
43	466.2625	12.5 kHz
44	466.2875	12.5 kHz
45	466.3125	12.5 kHz
46	466.3375	12.5 kHz
47	466.3625	12.5 kHz
48	467.7875	12.5 kHz

### *RM UHF Frequencies (Continued)*

Frequency #	Frequency (MHz)	Bandwidth
49	467.8375	12.5 kHz
50	467.8625	12.5 kHz
51	467.8875	12.5 kHz
52	467.9125	12.5 kHz
53	469.4875	12.5 kHz
54	469.5125	12.5 kHz
55	469.5375	12.5 kHz
56	469.5625	12.5 kHz
57	462.1875	12.5 kHz
58	462.4625	12.5 kHz
59	462.4875	12.5 kHz
60	462.5125	12.5 kHz

Frequency #	Frequency (MHz)	Bandwidth
61	467.1875	12.5 kHz
62	467.4625	12.5 kHz
63	467.4875	12.5 kHz
64	467.5125	12.5 kHz
65	451.1875	12.5 kHz
66	451.2375	12.5 kHz
67	451.2875	12.5 kHz
68	451.3375	12.5 kHz
69	451.4375	12.5 kHz
70	451.5375	12.5 kHz
71	451.6375	12.5 kHz
72	452.3125	12.5 kHz

### RM UHF Frequencies (cont.)

Frequency #	Frequency (MHz)	Bandwidth
73	452.5375	12.5 kHz
74	452.4125	12.5 kHz
75	452.5125	12.5 kHz
76	452.7625	12.5 kHz
77	452.8625	12.5 kHz
78	456.1875	12.5 kHz
79	456.2375	12.5 kHz
80	456.2875	12.5 kHz
81	456.3375	12.5 kHz

Frequency #	Frequency (MHz)	Bandwidth
82	456.4375	12.5 kHz
83	456.5375	12.5 kHz
84	456.6375	12.5 kHz
85	457.3125	12.5 kHz
86	457.4125	12.5 kHz
87	457.5125	12.5 kHz
88	457.7625	12.5 kHz
89	457.8625	12.5 kHz

#### Notes:

- When referring to XTN radios, note that frequencies from # 57 to # 89 are 33 new additional frequencies

## RMU2080 - UHF DEFAULT FREQUENCIES CHART

### *RM UHF 8 CH Radios Default Frequencies – RMU2080*

Channel	Frequency #	Frequency (MHz)	Code #	Code	Bandwidth
1	2	464.5500	1	67.0 Hz	12.5 kHz
2	8	467.9250	1	67.0 Hz	12.5 kHz
3	5	467.8500	1	67.0 Hz	12.5 kHz
4	6	467.8750	1	67.0 Hz	12.5 kHz
5	10	461.0625	1	67.0 Hz	12.5 kHz
6	12	461.1125	1	67.0 Hz	12.5 kHz
7	14	461.1625	1	67.0 Hz	12.5 kHz
8	WC	162.4000	1	67.0 Hz	12.5 kHz

WC = Weather Channel Frequency



## CTCSS AND PL/DPL CODES

### CTCSS Codes

CTCSS	Hz		CTCSS	Hz		CTCSS	Hz
1	67.0		14	107.2		27	167.9
2	71.9		15	110.9		28	173.8
3	74.4		16	114.8		29	179.9
4	77.0		17	118.8		30	186.2
5	79.7		18	123		31	192.8
6	82.5		19	127.3		32	203.5
7	85.4		20	131.8		33	210.7
8	88.5		21	136.5		34	218.1
9	91.5		22	141.3		35	225.7
10	94.8		23	146.2		36	233.6
11	97.4		24	151.4		37	241.8
12	100.0		25	156.7		38	250.3
13	103.5		26	162.2		122 (*)	69.3

**Note:** (\*) New CTCSS code.

*PL/DPL Codes*

DPL	Code		DPL	Code		DPL	Code
39	23		55	116		71	243
40	25		56	125		72	244
41	26		57	131		73	245
42	31		58	132		74	251
43	32		59	134		75	261
44	43		60	143		76	263
45	47		61	152		77	265
46	51		62	155		78	271
47	54		63	156		79	306
48	65		64	162		80	311
49	71		65	165		81	315
50	72		66	172		82	331
51	73		67	174		83	343
52	74		68	205		84	346
53	114		69	223		85	351
54	115		70	226		86	364

***PL/DPL Codes (Continued)***

<b>DPL</b>	<b>Code</b>		<b>DPL</b>	<b>Code</b>		<b>DPL</b>	<b>Code</b>
87	365		104	565		121	754
88	371		105	606		123	645
89	411		106	612		124	Customized PL
90	412		107	624		125	Customized PL
91	413		108	627		126	Customized PL
92	423		109	631		127	Customized PL
93	431		110	632		128	Customized PL
94	432		111	654		129	Customized PL
95	445		112	662		130	Inverted DPL 39
96	464		113	664		131	Inverted DPL 40
97	465		114	703		132	Inverted DPL 41
98	466		115	712		133	Inverted DPL 42
99	503		116	723		134	Inverted DPL 43
100	506		117	731		135	Inverted DPL 44
101	516		118	732		136	Inverted DPL 45
102	532		119	734		137	Inverted DPL 46
103	546		120	743		138	Inverted DPL 47

**PL/DPL Codes (Continued)**

<b>DPL</b>	<b>Code</b>		<b>DPL</b>	<b>Code</b>		<b>DPL</b>	<b>Code</b>
139	Inverted DPL 48		156	Inverted DPL 65		173	Inverted DPL 82
140	Inverted DPL 49		157	Inverted DPL 66		174	Inverted DPL 83
141	Inverted DPL 50		158	Inverted DPL 67		175	Inverted DPL 84
142	Inverted DPL 51		159	Inverted DPL 68		176	Inverted DPL 85
143	Inverted DPL 52		160	Inverted DPL 69		177	Inverted DPL 86
144	Inverted DPL 53		161	Inverted DPL 70		178	Inverted DPL 87
145	Inverted DPL 54		162	Inverted DPL 71		179	Inverted DPL 88
146	Inverted DPL 55		163	Inverted DPL 72		180	Inverted DPL 89
147	Inverted DPL 56		164	Inverted DPL 73		181	Inverted DPL 90
148	Inverted DPL 57		165	Inverted DPL 74		182	Inverted DPL 91
149	Inverted DPL 58		166	Inverted DPL 75		183	Inverted DPL 92
150	Inverted DPL 59		167	Inverted DPL 76		184	Inverted DPL 93
151	Inverted DPL 60		168	Inverted DPL 77		185	Inverted DPL 94
152	Inverted DPL 61		169	Inverted DPL 78		186	Inverted DPL 95
153	Inverted DPL 62		170	Inverted DPL 79		187	Inverted DPL 96
154	Inverted DPL 63		171	Inverted DPL 80		188	Inverted DPL 97
155	Inverted DPL 64		172	Inverted DPL 81		189	Inverted DPL 98

***PL/DPL Codes (Continued)***

<b>DPL</b>	<b>Code</b>		<b>DPL</b>	<b>Code</b>		<b>DPL</b>	<b>Code</b>
190	Inverted DPL 99		200	Inverted DPL 109		210	Inverted DPL 119
191	Inverted DPL 100		201	Inverted DPL 110		211	Inverted DPL 120
192	Inverted DPL 101		202	Inverted DPL 111		212	Inverted DPL 121
193	Inverted DPL 102		203	Inverted DPL 112		213	Inverted DPL 123
194	Inverted DPL 103		204	Inverted DPL 113		214	Customized DPL
195	Inverted DPL 104		205	Inverted DPL 114		215	Customized DPL
196	Inverted DPL 105		206	Inverted DPL 115		216	Customized DPL
197	Inverted DPL 106		207	Inverted DPL 116		217	Customized DPL
198	Inverted DPL 107		208	Inverted DPL 117		218	Customized DPL
199	Inverted DPL 108		209	Inverted DPL 118		219	Customized DPL

# MOTOROLA LIMITED WARRANTY FOR THE UNITED STATES AND CANADA

## What Does this Warranty Cover?

Subject to the exclusions contained below, Motorola, Inc. warrants its telephones, pagers, and consumer and business two-way radios (excluding commercial, government or industrial radios) that operate via Family Radio Service or General Mobile Radio Service, Motorola-branded or certified accessories sold for use with these Products (“Accessories”) and Motorola software contained on CD-ROMs or other tangible media and sold for use with these Products (“Software”) to be free from defects in materials and workmanship under normal consumer usage for the period(s) outlined below.

This limited warranty is a consumer’s exclusive remedy, and applies as follows to new Motorola Products, Accessories and Software purchased by consumers in the United States, which are accompanied by this written warranty.

## Products and Accessories

Products Covered	Length of Coverage
<b>Products and Accessories</b> as defined above, unless otherwise provided for below.	<b>One (1) year</b> from the date of purchase by the first consumer purchaser of the product unless otherwise provided for below.
<b>Decorative Accessories and Cases.</b> Decorative covers, bezels, PhoneWrap™ covers and cases.	<b>Limited lifetime warranty</b> for the lifetime of ownership by the first consumer purchaser of the product.
<b>Business Two-way Radio Accessories</b>	<b>One (1) year</b> from the date of purchase by the first consumer purchaser of the product.
<b>Products and Accessories that are Repaired or Replaced.</b>	<b>The balance of the original warranty or for ninety (90) days</b> from the date returned to the consumer, whichever is longer.

## Exclusions

**Normal Wear and Tear.** Periodic maintenance, repair and replacement of parts due to normal wear and tear are excluded from coverage.

**Batteries.** Only batteries whose fully charged capacity falls below 80% of their rated capacity and batteries that leak are covered by this limited warranty.

**Abuse & Misuse.** Defects or damage that result from: (a) improper operation, storage, misuse or abuse, accident or neglect, such as physical damage (cracks, scratches, etc.) to the surface of the product resulting from misuse; (b) contact with liquid, water, rain, extreme humidity or heavy perspiration, sand, dirt or the like, extreme heat, or food; (c) use of the Products or Accessories for commercial purposes or subjecting the Product or Accessory to abnormal usage or conditions; or (d) other acts which are not the fault of Motorola, are excluded from coverage.

**Use of Non-Motorola Products and Accessories.** Defects or damage that result from the use of Non-Motorola branded or certified Products, Accessories, Software or other peripheral equipment are excluded from coverage.

**Unauthorized Service or Modification.** Defects or damages resulting from service, testing, adjustment, installation, maintenance, alteration, or modification in any way by someone other than Motorola, or its authorized service centers, are excluded from coverage.

**Altered Products.** Products or Accessories with (a) serial numbers or date tags that have been removed, altered or obliterated; (b) broken seals or that show evidence of tampering; (c) mismatched board serial numbers; or (d) nonconforming or non-Motorola housings, or parts, are excluded from coverage.

**Communication Services.** Defects, damages, or the failure of Products, Accessories or Software due to any communication service or signal you may subscribe to or use with the Products Accessories or Software is excluded from coverage.

## Software

Products Covered	Length of Coverage
<b>Software.</b> Applies only to physical defects in the media that embodies the copy of the software (e.g. CD-ROM, or floppy disk).	<b>Ninety (90) days</b> from the date of purchase.

## Exclusions

**Software Embodied in Physical Media.** No warranty is made that the software will meet your requirements or will work in combination with any hardware or software applications provided by third parties, that the operation of the software products will be uninterrupted or error free, or that all defects in the software products will be corrected.

## Software NOT Embodied in Physical Media.

Software that is not embodied in physical media (e.g. software that is downloaded from the internet), is provided “as is” and without warranty.

## WHO IS COVERED?

This warranty extends only to the first consumer purchaser, and is not transferable.

## HOW TO OBTAIN WARRANTY SERVICE OR OTHER INFORMATION?

Contact your Motorola point of purchase.

## SOFTWARE COPYRIGHT NOTICE

The Motorola products described in this manual may include copyrighted Motorola and third party software stored in semiconductor memories or other media. Laws in the United States and other countries preserve for Motorola and third party software providers certain exclusive rights for copyrighted software, such as the exclusive rights to distribute or reproduce the copyrighted software. Accordingly, any copyrighted software contained in the Motorola products may not be modified, reverse-engineered, distributed, or reproduced in any manner to the extent allowed by law.



Furthermore, the purchase of the Motorola products shall not be deemed to grant either directly or by implication, estoppel, or otherwise, any license under the copyrights, patents, or patent applications of Motorola or any third party software provider, except for the normal, non-exclusive, royalty-free license to use that arises by operation of law in the sale of a product.

### **PATENT NOTICE**

This product is covered by one or more of the following United States patents.

5896277 5894292 5864752 5699006 5742484  
D408396 D399821 D387758 D389158  
5894592 5893027 5789098 5734975 5861850  
D395882 D383745 D389827 D389139 5929825  
5926514 5953640 6071640 D413022 D416252  
D416893 D433001

### **EXPORT LAW ASSURANCES**

This product is controlled under the export regulations of the United States of America. The Governments of the United States of America may restrict the exportation or re-exportation of this product to certain destinations. For further information contact the U.S. Department of Commerce.

# ACCESSORIES

## AUDIO ACCESSORIES

Part No.	Description
53815	Headset w/Boom Mic BR
HMN9026ER	Remote Speaker Mic BR
HKLN4477B	Surveillance Earpiece BR

Part No.	Description
53865	Headset w/Swivel Boom Mic
53866	Earbud w/Clip PTT Mic BR
56517	Earpiece w/Inline Mic
RLN6423B	Swivel Earpiece BR

## BATTERY

Part No.	Description
PMNN4434AR	Standard Li-Ion Battery
PMNN4453AR	High Capacity Li-Ion Battery

**CARRY ACCESSORIES**

Part No.	Description
HKLN4510A	Swivel Holster

**CABLES**

Part No.	Description
HKKN4028A	Radio to Radio Cloning Cable
HKKN4027A	CPS Programming Cable

**CHARGERS**

Part No.	Description
PMLN6384A	Multi Unit Charger (MUC) Kit - North America
PMLN6394A	Standard Drop-in Tray Charger

Features	Programmable Via Advanced Conf.		Programmable via CPS		Default Value	Programming Tips
	Display	Non- Display	Display	Non- Display		
Backlight	No	N/A	Yes	N/A	5 Seconds	Choose the backlight's time out by using the CPS.
Battery Save (2)	No	No	Yes	Yes	ON	Toggle On/Of via CPS only
Buttons Reset	No	No	Yes	Yes	ON	Available only via CPS. Allows resetting the radio buttons to factory default values. Refer to Radio Buttons Summary Table.

Features	Programmable Via Advanced Conf.		Programmable via CPS		Default Value	Programming Tips
	Display	Non-Display	Display	Non-Display		
Call Tones (4)	Yes	No	Yes	Yes	OFF / BUTTON A	Advanced Configuration available only for Display Models by going into Advanced Configuration Mode(1). Values available are 0 (OFF),1, 2 and 3. To enable/disable Call Tones press Button A (default button).
Channel Aliasing	Yes	N/A	Yes	N/A	OFF	Only Display Models. To enter or exit Channel Aliasing mode press PTT and "A" buttons simultaneously while turning radio ON for 3 sec. After editing, to exit and save, long press PTT. <b>Note:</b> To edit, refer to <i>Programming Features/Editing Channels</i> .
Channels	Yes	Yes	Yes	Yes	Model Dependant	You can select channels using the Channel Selector Knob (non-display models) or the MENU button (display models). You can also add or delete channels by using the CPS.  <b>Note:</b> <i>Enabling/disabling channels via CPS will automatically affect the Max Channels you are able to program via front panel.</i>

Features	Programmable Via Advanced Conf.		Programmable via CPS		Default Value	Programming Tips
	Display	Non-Display	Display	Non-Display		
Cloning Mode	Yes	Yes	Yes	Yes	Enable	Enables radio to enter cloning mode in order to clone its profile settings into other radios (using Radio to Radio Cloning Cable or Multi-Unit Charger). Press PTT, SB2 while turning radio ON. <b>Note:</b> You can clone radios using the CPS.
CPS Manager Lock	No	No	Yes	Yes	N/A	This feature is referred in the CPS software as "Codeplug Password". It prevents unauthorized access to the CPS to the radio's programmed configuration. Make sure you set up a 4 digits password that is easy to remember.
End of Tx Tone (or Roger Beep) (2)	Yes	Yes	Yes	Yes	OFF	To enable/disable press SB1 while powering up the radio
Frequencies	Yes	Yes	Yes	Yes	Channel and Model Dependant	There are 27 VHF frequencies and 89 UHF frequencies available. Use Advanced Configuration Mode (1) for configuration via the front panel radio programming. Refer to Frequencies and Codes Charts Section for details.

Features	Programmable Via Advanced Conf.		Programmable via CPS		Default Value	Programming Tips
	Display	Non-Display	Display	Non-Display		
<b>Bandwidth Range</b>	N/A	N/A	N/A	N/A	Model Dependant	Radios Bandwidth is fixed and non-programmable. Bandwidth Range for 2W radios: VHF 150.8 - 162 Mhz / UHF 450-470 Mhz
<b>Codes, Interference Eliminator Codes (CTCSS/DPL)</b>	Yes	Yes	Yes	Yes	Channel and Model Dependant	Use Advanced Configuration Mode for front panel radio configuration. There are 122 codes available. For details refer to Frequencies and Codes Charts Section.
<b>IVOX, enable/disable</b>	Yes	N/A	Yes	Yes	OFF	Hands free without accessories. To enable IVOX long press the PTT button while turning radio ON and until the IVOX icon blinks on Display model.

Features	Programmable Via Advanced Conf.		Programmable via CPS		Default Value	Programming Tips
	Display	Non-Display	Display	Non-Display		
<b>IVOX, sensitivity Level</b>	Yes	N/A	Yes	N/A	HIGH (Level 3)	Available for Display models only. Allows user to specify IVOX sensitivity level. For front panel radio programming use the MENU button.
<b>Keypad Beep ( or Keypad Tone) (2)</b>	Yes	Yes	Yes	Yes	ON	Press SB2 while turning ON radio to enable/disable keypad beep.
<b>Keypad Lock (2)</b>	Yes	N/A	Yes	N/A	UNLOCKED	Press and hold MENU for 4 seconds to lock the radio keypad. To unlock, press MENU for 4
<b>LEDs Enabled/ Disabled</b>	No	No	Yes	Yes	Enabled	seconds. Using CPS you can disable radio LEDs
<b>Low Battery Alert - Shutdown</b>	N/A	N/A	N/A	N/A	ON	Gives a sequence of loud and high beep tones to alert battery level is low. LED will blink orange several times. This a non-programmable feature.



Features	Programmable Via Advanced Conf.		Programmable via CPS		Default Value	Programming Tips
	Display	Non-Display	Display	Non-Display		
Maximum Channels (2)	Yes	Yes	Yes	Yes	Model and CPS programmable dependant	Use the Advanced Configuration mode to get the Active Channels Menu option. <b>Note:</b> Default value is set to the maximum number of channels that the radio supports.
Microphone Gain Level, ACCESSORY	Yes	No	Yes	Yes	Medium (Level 2)	For front panel programming enter in Advanced Configuration Mode (1).
Microphone Gain Level, RADIO	Yes	No	Yes	Yes	Medium (Level 2)	For front panel programming enter in Advanced Configuration Mode (1).
Monitor (4)	Yes	Yes	Yes	Yes	SB1 Button	Long Press SB1 to monitor and press SB1 again to release. <b>Note:</b> PL/DPL defeat feature should be disabled in order to monitor.

Features	Programmable Via Advanced Conf.		Programmable via CPS		Default Value	Programming Tips
	Display	Non-Display	Display	Non-Display		
<b>Nuisance Ch Delete (4)</b>	Yes	Yes	Yes	Yes	SB2 Button	<p>Press SB2 to start scanning and wait until the radio lands on the channel you want to delete. Long press SB2 to delete the channel.</p> <p><b>Note:</b> <i>The nuisance deleted channel will be restored into the scan list when the radio is turned OFF or you exit SCAN.</i></p>
<b>PL Defeat</b>	Yes	Yes	Yes	Yes	SB1 Button	<p>Also known as 'Squelch defeat'. Short Press SB1 to enable PL/DPL defeat so you can listen or monitor any activity in the channel without noise. Press SB1 again to disable PL/DPL defeat.</p>
<b>Power Select (4)</b>	Yes	Yes	Yes	Yes	2W (1W Model dependant)	<p>Use CPS to program an SBx button to be used for selecting the transmission power level you want for each channel. <b>Note:</b> <i>There may be power restrictions depending on the frequency chosen in each channel.</i></p>

Features	Programmable Via Advanced Conf.		Programmable via CPS		Default Value	Programming Tips
	Display	Non-Display	Display	Non-Display		
<b>Power up Text</b>	No	N/A	Yes	N/A	MOTOROLA	Text that shows up in the radio display when turned ON. Default text is MOTOROLA. Programmable via CPS.
<b>Reset to Factory Defaults (2)</b>	Yes	Yes	Yes	Yes	Enabled	Allows to restore radio's factory defaults. Press PTT, SB1, SB2 simultaneously for 3 seconds while turning ON radio.
<b>Reverse Burst</b>	No	No	Yes	Yes	180	Reverse Burst eliminates unwanted noise (squelch tail) during loss of carrier detection. Use CPS to select values 180 or 240.

Features	Programmable Via Advanced Conf.		Programmable via CPS		Default Value	Programming Tips
	Display	Non-Display	Display	Non-Display		
Scan	Yes	Yes	N/A	N/A	SB2 Button	Short press SB2 to enable/disable scan.
Multiple (16) Scan Lists	Yes	No	Yes	Yes	ON - All Channels	Use CPS for editing Scan Lists (adding/removing channels to be scanned). For display models only: you can add/delete channels in the scan lists using front panel by going into Adv. Config. mode.
Scan, Auto Scan	No	Yes	No	Yes	OFF	Feature available only for Non Display Models. For front programming using front panel radio enter in Advanced Configuration Mode(1)
Scramble (4)	Yes	No	Yes	Yes	OFF (level 0)	Display models: you can program scramble using front panel by going into Advanced Configuration Mode(1). Non-display model you
Time-Out Timer	No	No	Yes	Yes	60 seconds	Use CPS to program to program how long the PTT can be pressed before the transmission is automatically terminated. Values are 60, 120 and 180 seconds. (Pressing again PTT will start the transmission again).

Features	Programmable Via Advanced Conf.		Programmable via CPS		Default Value	Programming Tips
	Display	Non-Display	Display	Non-Display		
<b>VOX Sensitivity Level</b>	Yes	No	Yes	Yes	OFF (level 0)	Front panel radio programming available in display models by pressing PTT or MENU buttons and scrolling down/up with "A" and "B" buttons to set value. Long press PTT to save.
<b>VOX, enable/disable</b>	Yes	Yes	Yes	Yes	OFF	Allows to use 'hands-free' mode connecting microphone accessories. To enable connect external accessory and power up radio.  <b>Note:</b> The VOX sensitivity level default value is set to OFF in the CPS settings. Before using this feature, check VOX sensitivity level.

- (1) To enter in Advanced Configuration Mode, press and hold both PTT and SB1 simultaneously for 3-5 seconds while turning radio ON (LED will start to blink green). Short press PTT to get to the different programming options.
- (2) Using CPS you can prevent this feature to be programmed via front panel radio.
- (3) Contact your Motorola Point of purchase for enabling this feature and/or for radio models details.
- (4) For Non-Display Models, feature can be enabled for front panel programming by assigning feature to SB1 or SB2. For Display models: Feature can be enabled to any of the programmable buttons rather than the default ones. For more details refer to Programming Buttons Chart or CPS Menus.

# New Features

Features	Programmable Via Advanced Conf.		Programmable via CPS		Default Value	Programming Tips
	Display	Non-Display	Display	Non-Display		
Channel Busy Lock out	No	No	Yes	Yes	OFF	This feature prevents the radio's transmitter from being activated if a signal strong enough to break through the "noise" squelch is present.
Silent mode	No	No	Yes	Yes	OFF	Silent mode is only active when VOX/IVOX is activated. Choices available are: - OFF (Default): The radio will work in normal mode. - Accessory Audio Only: Audio is only played through acc. - No Audio: Audio is disabled even the received audio.
Power Up Audio	No	No	Yes	Yes	Tone Only + Channel	Selects the audio the radio will play when it is powered up.
Priority Scan	No	No	Yes	yes	OFF	Set the current channel with high priority scan. If Weather Alert is enabled and the radio is in Two-way mode, the radio shall enable Weather Alert Scan and ignore priority scan, talkaround scan, or auto scan.
Pre-Defined Voice Prompt (VP)	No	No	Yes	Yes	Channel Number	16 pre defined channel aliases to select for voice announcement

## Programmable Buttons Chart

Button	Monitor	Scan / Nuisance Delete	Call Tone	Power Select	Scramble	No Operation
SB1	Default	✓	✓	✓	✓	✓
SB2	✓	Default	✓	✓	✓	✓

### Notes:

- Buttons come programmed to default functions. Using CPS you can assign one of the features shown in the chart, so the button can toggle values using radio front panel.



MOTOROLA, MOTO, MOTOROLA SOLUTIONS and the Stylized M Logo are trademarks or registered trademarks of Motorola Trademark Holdings, LLC and are used under license. All other trademarks are the property of their respective owners. ©2013 Motorola, Inc. All rights reserved. Printed in Malaysia.



68012009072