

KENWOOD

INSTRUCTION MANUAL



VHF FM TRANSCEIVER

TK-2200

UHF FM TRANSCEIVER

TK-3200

KENWOOD CORPORATION

© B62-1791-00 (K,K2)
09 08 07 06 05 04 03 02 01 00

THANK YOU

We are grateful for your purchase of this **KENWOOD** product and welcome you to the Business Radio Service (BRS).

Your **KENWOOD** 2-way Business Radio is called a “transceiver”, meaning “transmitter & receiver”. We believe this easy-to-use transceiver will provide you with dependable and reliable communications. This **KENWOOD** transceiver is a precision device. Treat it with care, and you will enjoy years of reliable operation.

MODELS COVERED BY THIS MANUAL

TK-2200 (K): 2-channel VHF FM Transceiver

TK-3200 (K): 2-channel UHF FM Transceiver

TK-2200 (K2): 8-channel VHF FM Transceiver

TK-3200 (K2): 8-channel UHF FM Transceiver

FEATURES

- 2 channels (K) or 8 channels (K2) with 27 operating frequencies (TK-2200) or 56 operating frequencies (TK-3200) and 122 tone/ code settings for each channel allowing you to ignore unwanted calls.
- Built in voice scrambler gives you complete privacy for your conversations.
- Hands free operation when using an optional headset.
- Voice announcement lets you know which channel you have selected and which settings you have made when reassigning key functions and channel settings.

OPERATING CONDITIONS

Open locations (no obstructions)	Up to 6 miles (approximately 9.6 km)
Residential areas (near buildings)	Up to 1.5 miles (approximately 2.4 km)
In steel/ concrete reinforced buildings	Up to 250,000 square feet (approximately 23,225 m ²)
In high rises	Up to 20 floors

Note: The listed ranges are based on field testing and may vary with your operating conditions and individual transceiver.

FCC LICENSE INFORMATION

Your **KENWOOD** transceiver operates on communications frequencies which are subject to FCC (Federal Communications Commission) Rules & Regulations. FCC Rules require that all operators using Private Land Mobile radio frequencies obtain a radio license before operating their equipment. Application for license must be made on FCC form 601, schedules D and H, and Remittance form 159

FAX: Forms can be obtained by fax from the FCC Fax-On-Demand system. Call 1-202-418-0177 from your fax machine and request document number 000601 for the form, schedules, and instructions.

MAIL: Forms can be ordered by telephone, and will be sent to you by first class mail. Call the FCC Forms Hotline at 1-800-418-FORM (1-800-418-3676).

INTERNET: Form 601 and instructions can be downloaded from the FCC Forms website at <http://www.fcc.gov/formpage.html>

Before filling out your Form 601 application Technical Data section, you must decide on which frequencies you will operate. See the frequency charts on pages 18 and 19.

QUESTIONS? Call the FCC for license application questions at 1-888-CALL-FCC (1-888-225-5322).

CHANNEL SPACING

The TK-2200 uses 25 kHz channel spacing and the TK-3200 uses 12.5 kHz channel spacing per FCC regulations. Optimal sound quality may not be obtained when communicating with other transceivers that do not have these channel spacing parameters.

PRECAUTIONS

- Refer service to qualified technicians only. Do not modify or attempt to adjust this transceiver for any reason.
- Do not expose the transceiver to long periods of direct sunlight, nor place it close to heating appliances.
- Do not place the transceiver in excessively dusty, humid, or wet areas, nor on unstable surfaces.
- Avoid extremes in exposure to weather, heat, and cold. This transceiver can be used in mild weather conditions, but it is not waterproof.
- Turn OFF your transceiver while taking on fuel or while parked in gasoline service stations.
- Do not operate your transceiver or charge your battery pack in an explosive atmosphere (gases, dust, fumes, etc.).
- If an abnormal odor or smoke is detected coming from the transceiver, immediately switch OFF the power and remove the battery pack from the transceiver. Contact your **KENWOOD** dealer.

NOTICES TO THE USER

- ◆ Government law prohibits the operation of unlicensed radio transmitters within the territories under government control.
- ◆ Illegal operation is punishable by fine and/or imprisonment.
- ◆ Refer service to qualified technicians only.

Safety: It is important that the operator is aware of, and understands, hazards common to the operation of any transceiver.



WARNING

EXPLOSIVE ATMOSPHERES (GASES, DUST, FUMES, etc.)

Turn off your transceiver while taking on fuel, or while parked in gasoline service stations.

One or more of the following statements may be applicable:

FCC WARNING

This equipment generates or uses radio frequency energy. Changes or modifications to this equipment may cause harmful interference unless the modifications are expressly approved in the instruction manual. The user could lose the authority to operate this equipment if an unauthorized change or modification is made.

INFORMATION TO THE DIGITAL DEVICE USER REQUIRED BY THE FCC

This equipment has been tested and found to comply with the limits for a Class B digital device, pursuant to Part 15 of the FCC Rules. These limits are designed to provide reasonable protection against harmful interference in a residential installation.

This equipment generates, uses and can generate radio frequency energy and, if not installed and used in accordance with the instructions, may cause harmful interference to radio communications. However, there is no guarantee that the interference will not occur in a particular installation. If this equipment does cause harmful interference to radio or television reception, which can be determined by turning the equipment off and on, the user is encouraged to try to correct the interference by one or more of the following measures:

- Reorient or relocate the receiving antenna.
- Increase the separation between the equipment and receiver.
- Connect the equipment to an outlet on a circuit different from that to which the receiver is connected.
- Consult the dealer for technical assistance.

FCC REGULATIONS REGARDING THE USE OF THE EMERGENCY CHANNEL

The communications must be for the purpose of soliciting or rendering assistance to a traveler, or for communicating in an emergency pertaining to the immediate safety of life or the immediate protection of property.



ATTENTION (U.S.A. Only):

The RBRC Recycle seal found on **KENWOOD** nickel metal hydride (Ni-MH) battery packs indicates **KENWOOD's** voluntary participation in an industry program to collect and recycle Ni-MH batteries after their operating life has expired. The RBRC program is an alternative to disposing Ni-MH batteries with your regular refuse or in municipal waste streams, which is illegal in some areas.

For information on Ni-MH battery recycling in your area, call (toll free) 1-800-8-BATTERY (1-800-822-8837).

KENWOOD's involvement in this program is part of our commitment to preserve our environment and conserve our natural resources.

CONTENTS

UNPACKING AND CHECKING EQUIPMENT	1
SUPPLIED ACCESSORIES	1
ORIENTATION	3
PREPARATION	4
CHARGING THE Ni-MH BATTERY PACK	4
INSTALLING/ REMOVING THE BATTERY PACK	6
INSTALLING THE OPTIONAL ANTENNA	7
INSTALLING THE BELT CLIP	7
INSTALLING THE COVER OVER THE SPEAKER/ MICROPHONE JACKS	8
INSTALLING THE OPTIONAL SPEAKER/ MICROPHONE (OR HEADSET)	8
GETTING STARTED	9
VOICE OPERATED TRANSMISSION (VOX)	10
VOX GAIN	10
VOX OPERATION	12
KEY FUNCTIONS	13
LOCK KEY	13
SCAN KEY	13
BACKGROUND OPERATIONS	15
TIME-OUT TIMER (TOT)	15
LOW BATTERY WARNING	15
CHANNEL ANNUNCIATION	15
QUIET TALK (QT)/ DIGITAL QUIET TALK (DQT)	16
CHANNEL SETUP MODE	17
CHANNEL OPERATING FREQUENCIES	18
QUIET TALK (QT)/ DIGITAL QUIET TALK (DQT) SETTINGS	21
KEY ASSIGNMENT MODE	25
CALLING ALERT	28
KEY LOCK	28
SUPER LOCK	28
MONITOR/ SQUELCH OFF	29
SCAN	29
SCRAMBLER	31
ALL RESET MODE	32
OPTIONAL ACCESSORIES	33
TROUBLESHOOTING GUIDE	34

UNPACKING AND CHECKING EQUIPMENT

Carefully unpack the transceiver. We recommend you identify the items listed in the following table before discarding the packing material. If any items are missing or have been damaged during shipment, file a claim with the carrier immediately.

SUPPLIED ACCESSORIES

Item	Part Number	Quantity
Rapid battery charger (KSC-31)	W08-0969-XX	1
AC adaptor	W08-0970-XX	1
Ni-MH battery pack (KNB-29N)	W09-1000-XX	1
Speaker/ microphone jack cover	B09-0680-XX	1
Speaker/ microphone locking bracket	J19-5472-XX	1
Belt clip	J29-0713-XX	1
Screw set	N99-2043-XX	1
Warranty card	— —	1
Instruction manual	B62-1791-XX	1



Rapid battery charger
(KSC-31)

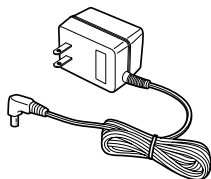

AC adaptor

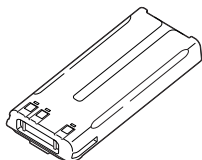

Ni-MH battery pack
(KNB-29N)



Speaker/ microphone
jack cover



Speaker/ microphone
locking bracket

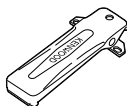

Belt clip



Screw set

ORIENTATION

Antenna
(optional)

LED indicator

Indicates the transceiver status. Lights red while transmitting, green while receiving, and flashes red while the battery power is low while transmitting.

Channel selector

Rotate to change the operating channel from 1 ~ 2 or 1 ~ 8.

**Power switch/
Volume control**

Turn clockwise to switch the power ON and counterclockwise to switch the power OFF. Rotate to adjust the volume.

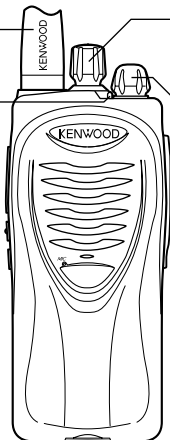

PTT (Push to Talk) switch

Press and hold, then speak into the microphone to transmit.

Lock key
Press and hold to lock the transceiver keys (page 13).

Scan key
Press to scan the channels for a signal or to remove a channel from scan (page 13).

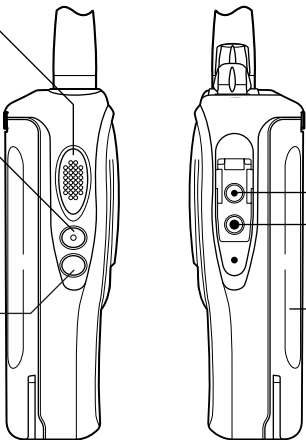

**Speaker/
microphone
jacks**

**Battery pack
(KNB-29N)**

Note: The **Lock** and **Scan** keys can be reprogrammed (page 25).

PREPARATION

CHARGING THE Ni-MH BATTERY PACK

The initial charging of the battery pack after purchase or extended storage (greater than 2 months) will not bring the battery pack to its normal operating capacity. After repeating the charge/discharge cycle 2 or 3 times, the operating capacity should increase to normal.



CAUTION

- ◆ Do not recharge the battery pack if it is already fully charged. Doing so may cause the life of the battery pack to shorten or the battery pack may be damaged.
- ◆ After recharging the battery pack, disconnect it from the charger. Charging the battery pack for more than 5 days may reduce the battery pack life due to overcharging.

Note:

- ◆ The ambient temperature should be between 41°F and 104°F (5°C and 40°C) while charging is in progress. Charging outside this range may not fully charge the battery.
 - ◆ Always switch OFF the transceiver equipped with a Ni-MH battery pack before charging. Using the transceiver while charging its battery pack will interfere with correct charging.
 - ◆ The battery pack life is over when its operating time decreases even though it is fully and correctly charged. Replace the battery pack.
-

1

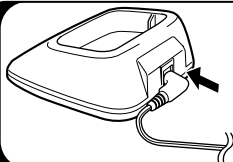

Plug the AC adaptor cable into the adaptor jack located at the rear of the charger.

2

Plug the AC adaptor into an AC outlet.

3

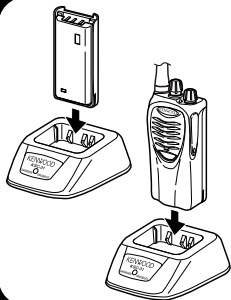

Slide the Ni-MH battery pack or transceiver with a Ni-MH battery pack into the charger.

- Make sure the battery pack terminals are in contact with the charger terminals by aligning the grooves of the battery pack with the tabs of the charger.
- The charger LED lights red and charging begins.

4

When charging is completed, the indicator lights green. Remove the battery pack or the transceiver with a battery pack from the charger.

- It takes approximately 3 hours to charge the battery pack.
- When the charger will not be used for a long time, unplug the AC adaptor from the AC outlet.

INSTALLING/ REMOVING THE BATTERY PACK

The battery pack is not charged at the factory; charge it before use (pages 5 and 6).

Average battery pack life (calculated using 5% transmit time, 5% receive time, and 90% standby time) is 17 hours.



CAUTION

- ◆ Do not short the battery terminals.
- ◆ Do not dispose of the battery by fire.
- ◆ Never attempt to remove the casing from the battery pack.

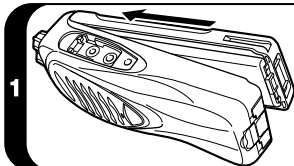

Align the battery pack with the back of the transceiver, then press the battery pack and transceiver firmly together until the release latch on the base of the transceiver locks.

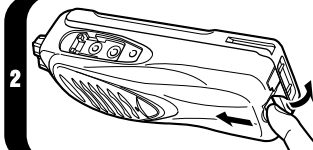

To remove the battery pack, lift the safety catch on the base of the transceiver, then press the release latch underneath the safety catch.

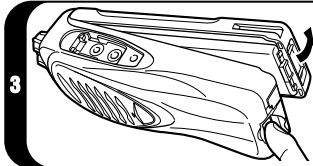

While pressing the release latch, pull the battery pack away from the transceiver.

INSTALLING THE OPTIONAL ANTENNA



Screw the antenna into the connector on the top of the transceiver by holding the antenna at its base and turning it clockwise until secure.

Note: The antenna is neither a handle, a key ring retainer, nor a speaker/ microphone attachment point. Using the antenna in these ways may damage the antenna and degrade your transceiver's performance.

INSTALLING THE BELT CLIP

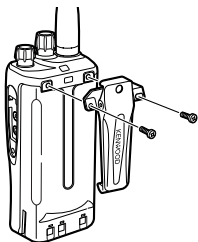

If necessary, attach the belt clip using the two supplied 3 x 8 mm screws.

Note: If the belt clip is not installed, its mounting location may get hot during continuous transmission or when left sitting in a hot environment.



CAUTION

Do not use glue which is designed to prevent screw loosening when installing the belt clip, as it may cause damage to the transceiver. Acrylic ester, which is contained in these glues, may crack the transceiver's back panel.

INSTALLING THE COVER OVER THE SPEAKER/ MICROPHONE JACKS

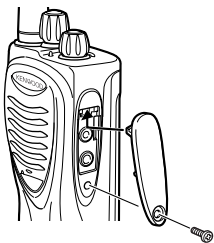

If you are not using a speaker/ microphone, install the cover over the speaker/ microphone jacks using the supplied 3 x 6 mm screw.

Note: To keep the transceiver water resistant, you must cover the speaker/ microphone jacks with the supplied cover.

INSTALLING THE OPTIONAL SPEAKER/ MICROPHONE (OR HEADSET)

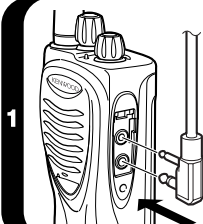

Insert the speaker/ microphone (or headset) plugs into the speaker/ microphone jacks.

Note: Always switch OFF the transceiver power when installing or removing a speaker/ microphone or headset.

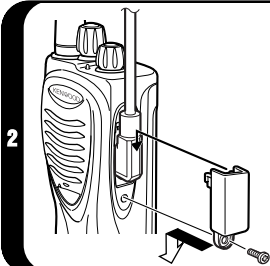

Attach the locking bracket using the supplied 3 x 6 mm screw.

Note: The transceiver is not fully water resistant while using the speaker/ microphone.

GETTING STARTED

1

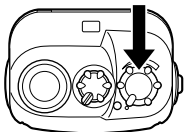

Turn the **Power** switch/ **Volume** control clockwise to switch the transceiver power ON.

- A beep sounds.

2

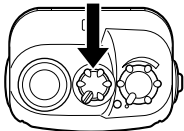

Rotate the **Channel** selector to select your desired channel.

- When you receive an appropriate signal, you will hear audio from the speaker. Adjust the volume as necessary.

3

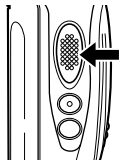

To make a call, press and hold the **PTT** switch, then speak into the microphone to transmit. Release the **PTT** switch to receive.

- The LED lights red while transmitting.
- For best sound quality, speak into the microphone in your normal voice while holding the microphone approximately 1.5 inches (3 to 4 cm) from your lips.

VOICE OPERATED TRANSMISSION (VOX)

Using the VOX feature, you can operate the transceiver hands-free. In order to use this feature, however, you must use an optional headset; VOX will not function with the built-in microphone. For best operating conditions, we recommend you use an optional headset with both an ear piece and a microphone on a boom that rests in front of your mouth.

With VOX activated, your voice level will determine when the transceiver transmits. Because of this, you must take care that the ambient noise around you is not so loud that it causes the transceiver to transmit. Due to the automatic switching between transmission and reception, we recommend you set the VOX Gain level such that it will not activate transmission when in an area with excessive ambient noise.

VOX GAIN

To activate VOX and set the VOX Gain level:

1



With the transceiver power OFF, connect the headset to the transceiver (page 8).

- The VOX function does not activate when a headset is not connected to the speaker/ microphone jack of the transceiver.

2



Press and hold the **Lock** key while turning the transceiver power ON.

- Continue to hold the **Lock** key until the LED flashes orange one time and the transceiver announces "VOX", then release the key. Upon releasing the key, the transceiver will announce the current VOX Gain level.

3

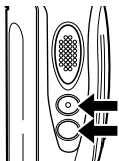

Press the **Lock** key to increase the VOX Gain level and the **Scan** key to decrease the level.

- The VOX Gain can be adjusted from level 1 to level 10 and OFF.
- The transceiver announces the VOX Gain level as you adjust it. If OFF is selected, the transceiver announces "Off".

4

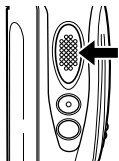

Press the **PTT** switch within 5 seconds to save the setting, otherwise the operation will cancel.

- A beep will sound and the transceiver will announce the new VOX Gain level.

5

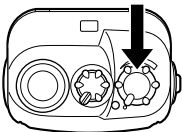

Turn the transceiver power OFF and then ON again to activate VOX.

Note:

- ◆ VOX Gain level 1 is the least sensitive and VOX Gain level 10 is the most sensitive.
- ◆ If a speaker/ microphone is connected to the transceiver while the VOX function is switched ON and the VOX Gain level is configured to a higher, more sensitive level, louder received signals may cause the transceiver to start transmission.
- ◆ The transceiver will automatically return to normal operation if no action is performed for 5 seconds.

VOX OPERATION

1 Set up a VOX Gain level from 1 to 10 (page 10).

2 To transmit, simply speak into the headset microphone.

- You do not need to press the **PTT** switch; the transceiver automatically detects your voice and begins transmitting.
- When you begin speaking, a beep will sound, informing you that the transceiver is transmitting.

3 To stop transmitting, stop speaking.

- Transmission will continue momentarily after you stop speaking, so ensure your transmission will not be cut off.

4 To exit VOX mode, set the VOX Gain level (page 10) to OFF.

Note:

- ◆ While transmitting via VOX, all keys other than power OFF are disabled.
 - ◆ When you operate the VOX function, you must use an optional KHS-1 or KHS-21 accessory.
 - ◆ VOX will not operate when the battery level becomes too low. (The LED will flash red in this state.)
-

KEY FUNCTIONS

LOCK KEY

The default function of the **Lock** key is Super Lock.

Super Lock is designed to prevent accidental function changes on your transceiver, during operation.

Press and hold the **Lock** key for 4 seconds to lock the transceiver keys. The **PTT** switch and the **Power** switch/**Volume** control can still be operated when Super Lock is active.

To deactivate Super Lock, with the transceiver power OFF, press and hold the **PTT** switch, the **Lock** key, and the **Scan** key for 2 seconds while turning the transceiver power ON.

SCAN KEY

The default function of the **Scan** key is Scan + Temporary Delete.

You can scan the channels of the transceiver to search for a signal. When the transceiver verifies a signal on a channel, it proceeds to check whether or not its QT/ DQT setting matches that which is set up on your transceiver (if any). If the QT/ DQT matches, the transceiver stops at the channel and opens the squelch so you can listen to the call. If the QT/ DQT does not match, the call is ignored and scanning continues.

Note: You can only use Scan if there are at least 2 channels available on your transceiver that are not locked out of Scan.

To start scanning, press the **Scan** key.

- The LED indicator flashes green and scanning starts from the current channel and ascends through the channel numbers.
- When a signal is detected on a channel and the QT/ DQT matches, scan pauses at that channel and the LED indicator lights green.
- When the signal is no longer present, scanning continues after 3 seconds (default).

To end Scan, press the **Scan** key again.

■ Temporary Delete

You can temporarily remove specific channels from the scanning sequence during Scan. When Scan pauses at a channel, you can remove that channel from the scanning sequence by pressing and holding the **Scan** key for 1 second.

- You cannot remove a channel if there will be less than 2 channels available for scanning remaining.
- To add the removed channels back into the Scan list, simply exit Scan mode or switch the transceiver power OFF and then ON again.

TIME-OUT TIMER (TOT)

The purpose of the Time-out Timer is to prevent you from using a channel for an extended period of time. This function is useful, for example, when you accidentally keep the **PTT** switch pressed. Additionally, by limiting the amount of time you can continuously transmit, this feature helps you save on battery power consumption.

If you continuously transmit for 60 seconds (default), the transceiver will stop transmitting and an alert tone will sound. To stop the tone, release the **PTT** switch. You can press the **PTT** switch again to resume transmitting.

LOW BATTERY WARNING

Low Battery Warning alerts you when the battery needs to be recharged or replaced.

While operating the transceiver, if the battery power becomes low, an alert tone will sound every 30 seconds and the LED indicator will blink red. Replace or recharge the battery pack at this time.

CHANNEL ANNUNCIATION

When changing the channel, the transceiver will announce the selected channel number after you stop changing the channel. Likewise, the transceiver will announce the current channel after you turn the transceiver power ON. (Channel Annunciation can be activated or deactivated by your dealer.)

QUIET TALK (QT)/ DIGITAL QUIET TALK (DQT)

Quiet Talk (QT) and Digital Quiet Talk (DQT) are functions that reject signals from undesired parties that are using the same channel as you. You will hear audio from the speaker only when you receive a signal that contains a QT tone or a DQT code that matches the one set up on the channel you are using. If a call containing a different tone or code is made on the same channel you are using, squelch will not open and you will not hear the call. Likewise, when you transmit on a channel set up with QT or DQT, the receiving station must have a matching tone or code in order to hear your call.

Although it may seem like you have your own private channel while using QT or DQT, other parties can still hear your calls if they set up their transceiver with the same tone or code.

The default QT/ DQT settings for each channel is 67.0 Hz.

CHANNEL SETUP MODE

This transceiver allows you to reprogram each of the channels with different frequencies and Quiet Talk/ Digital Quiet Talk settings. The table below lists the default channel frequencies. All channels are set with a 67.0 Hz QT tone by default.

Channel Number	Table Number	Frequency (MHz)	Table Number	Frequency (MHz)
TK-2200 (K)		TK-3200 (K)		
2-Channel Model		2-Channel Model		
1	3	154.5700	2	464.5500
2	4	154.6000	8	467.9250
TK-2200 (K2)		TK-3200 (K2)		
8-Channel Model		8-Channel Model		
1	3	154.5700	2	464.5500
2	4	154.6000	8	467.9250
3	5	151.7000	9	461.0375
4	6	151.7600	10	461.0625
5	7	151.8200	11	461.0875
6	8	151.8800	12	461.1125
7	9	151.9400	13	461.1375
8	10	151.5125	14	461.1625

Note: If you do not select an operating frequency for a channel, you will not be able to select a Quiet Talk/ Digital Quiet Talk setting for that same channel.

CHANNEL OPERATING FREQUENCIES

To change the operating frequency of a channel:

1



With the transceiver power OFF, press and hold the **PTT** switch and **Lock** key while turning the transceiver power ON.

- Continue to hold the **PTT** switch and **Lock** key until the LED flashes orange one time and the transceiver announces “Self”.

2

Release the **PTT** switch and **Lock** key.

- The transceiver announces “Channel”.
- Pressing the **Lock** key or **Scan** key will toggle between QT, DQT, and Channel setup.

3



Press and release the **PTT** switch, then rotate the **Channel** selector to your desired channel.

- Upon pressing and releasing the **PTT** switch, the transceiver announces “Table zero”.

4

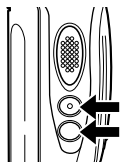

Press the **Lock** key to increment the Table number or the **Scan** key to decrement the number, to select the new channel frequency.

- Press and hold the **Lock** or **Scan** key to increment/ decrement the number by 5 at a time.
- Table numbers and their corresponding operating frequencies are provided in the table below.
- A voice announcement will inform you of the currently selected Table number.

5

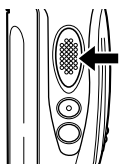

Press the **PTT** switch within 5 seconds to save the setting, otherwise the operation will cancel.

- A beep will sound and the transceiver will announce the new Table number.
- Repeat steps 3 to 5 to set up another channel.

6

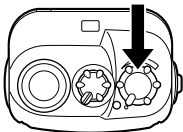

Turn the transceiver power **OFF** and then **ON** again to activate the new settings.

Note: The transceiver will automatically return to normal operation if no action is performed for 5 seconds.

TK-2200 Table Number	Operating Frequency (MHz)	TK-2200 Table Number	Operating Frequency (MHz)
0	OFF	14	151.7450
1	151.6250	15	151.7750
2	151.9550	16	151.8650
3	154.5700	17	151.8950
4	154.6000	18	151.9250
5	151.7000	19	152.7000
6	151.7600	20	154.4900
7	151.8200	21	154.5150
8	151.8800	22	154.5275
9	151.9400	23	154.5400
10	151.5125	24	154.6000
11	151.6550	25	154.6550
12	151.6850	26	158.4000
13	151.7150	27	158.4075

TK-3200 Table Number	Operating Frequency (MHz)	TK-3200 Table Number	Operating Frequency (MHz)
0	OFF		
1	464.5000	29	462.9125
2	464.5500	30	464.4875
3	467.7625	31	464.5125
4	467.8125	32	464.5375
5	467.8500	33	464.5625
6	467.8750	34	466.0375
7	467.9000	35	466.0625
8	467.9250	36	466.0875
9	461.0375	37	466.1125
10	461.0625	38	466.1375
11	461.0875	39	466.1625
12	461.1125	40	466.1875
13	461.1375	41	466.2125
14	461.1625	42	466.2375
15	461.1875	43	466.2625
16	461.2125	44	466.2875
17	461.2375	45	466.3125
18	461.2625	46	466.3375
19	461.2875	47	466.3625
20	461.3125	48	467.7875
21	461.3375	49	467.8375
22	461.3625	50	467.8625
23	462.7625	51	467.8875
24	462.7875	52	467.9125
25	462.8125	53	469.4875
26	462.8375	54	469.5125
27	462.8625	55	469.5375
28	462.8875	56	469.5625

QUIET TALK (QT)/ DIGITAL QUIET TALK (DQT) SETTINGS

To change the QT/ DQT settings of a channel:

1



With the transceiver power OFF, press and hold the **PTT** switch and **Lock** key while turning the transceiver power ON.

- Continue to hold the **PTT** switch and **Lock** key until the LED flashes orange one time and the transceiver announces “Self”.

2

Release the **PTT** switch and **Lock** key.

- The transceiver announces “Channel”.
- Pressing the **Lock** key or **Scan** key will toggle between QT, DQT, and Channel setup.

3

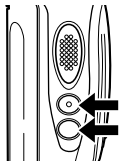

Press the **Lock** key or **Scan** key to select QT or DQT setup.

- The transceiver announces “QT” or “DQT”, depending on your selection.

4



Press and release the **PTT** switch, then rotate the **Channel** selector to your desired channel.

- Upon releasing the **PTT** switch, the transceiver announces “QT One” or “DQT One”, depending on your selection.

5

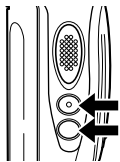

Press the **Lock** key to increment the Tone number or the **Scan** key to decrement the number, to select the new tone or code.

- Tone numbers and their corresponding tones/ codes are provided in the table below.
- Press and hold the **Lock** or **Scan** key to increment/ decrement the Tone number by 5 at a time.
- A voice announcement will inform you of the currently selected Tone number.

6

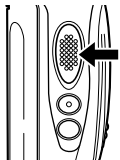

Press the **PTT** switch within 5 seconds to save the setting, otherwise the operation will cancel.

- A beep will sound and the transceiver will announce the new Tone number.
- Repeat steps 3 to 6 to set up another channel.

7

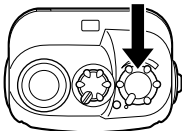

Turn the transceiver power **OFF** and then **ON** again to activate the new settings.

Note: The transceiver will automatically return to normal operation if no action is performed for 5 seconds.

Quiet Talk Channel Settings:

QT Number	Quiet Talk Frequency	QT Number	Quiet Talk Frequency	QT Number	Quiet Talk Frequency
1	67.0 Hz	15	110.9 Hz	29	179.9 Hz
2	71.9 Hz	16	114.8 Hz	30	186.2 Hz
3	74.4 Hz	17	118.8 Hz	31	192.8 Hz
4	77.0 Hz	18	123.0 Hz	32	203.5 Hz
5	79.7 Hz	19	127.3 Hz	33	210.7 Hz
6	82.5 Hz	20	131.8 Hz	34	218.1 Hz
7	85.4 Hz	21	136.5 Hz	35	225.7 Hz
8	88.5 Hz	22	141.3 Hz	36	233.6 Hz
9	91.5 Hz	23	146.2 Hz	37	241.8 Hz
10	94.8 Hz	24	151.4 Hz	38	250.3 Hz
11	97.4 Hz	25	156.7 Hz	39	69.3 Hz
12	100.0 Hz	26	162.2 Hz	Off	OFF
13	103.5 Hz	27	167.9 Hz		
14	107.2 Hz	28	173.8 Hz		

Digital Quiet Talk Channel Settings:

DQT Number	Digital Quiet Talk Code	DQT Number	Digital Quiet Talk Code	DQT Number	Digital Quiet Talk Code
1	D023N	29	D174N	57	D445N
2	D025N	30	D205N	58	D464N
3	D026N	31	D223N	59	D465N
4	D031N	32	D226N	60	D466N
5	D032N	33	D243N	61	D503N
6	D043N	34	D244N	62	D506N
7	D047N	35	D245N	63	D516N
8	D051N	36	D251N	64	D532N
9	D054N	37	D261N	65	D546N
10	D065N	38	D263N	66	D565N
11	D071N	39	D265N	67	D606N
12	D072N	40	D271N	68	D612N
13	D073N	41	D306N	69	D624N
14	D074N	42	D311N	70	D627N
15	D114N	43	D315N	71	D631N
16	D115N	44	D331N	72	D632N
17	D116N	45	D343N	73	D654N
18	D125N	46	D346N	74	D662N
19	D131N	47	D351N	75	D664N
20	D132N	48	D364N	76	D703N
21	D134N	49	D365N	77	D712N
22	D143N	50	D371N	78	D723N
23	D152N	51	D411N	79	D731N
24	D155N	52	D412N	80	D732N
25	D156N	53	D413N	81	D734N
26	D162N	54	D423N	82	D743N
27	D165N	55	D431N	83	D754N
28	D172N	56	D432N	Off	OFF

KEY ASSIGNMENT MODE

This transceiver allows you to reprogram the **Lock** and **Scan** keys with any of the functions listed in the table below. Explanations on the use of each function are provided on the following pages.

Table Number	Function Name
0	None (no function)
1	Calling Alert
2	Key Lock
3	Super Lock (Lock key default)
4	Monitor
5	Monitor Momentary
6	Scan
7	Scan + Temporary Delete (Scan key default)
8	Scrambler
9	Squelch Off
10	Squelch Off Momentary
11	Temporary Delete

To change the functions of the **Call** and **Monitor** keys:

1



With the transceiver power OFF, press and hold the **Lock** and **Scan** keys while turning the transceiver power ON.

- Continue to hold the **Lock** and **Scan** keys until the LED flashes orange one time and the transceiver announces “Setup”.

2

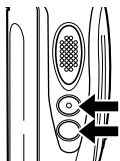

Continue to press and hold the key to be reprogrammed (either the **Lock** key or the **Scan** key), while releasing the remaining key.

- The transceiver will announce “Table zero” (as shown in the table above).
- If you continue to hold both keys, or if you release both keys, the operation will cancel in 5 seconds.

3

Release the key.

4

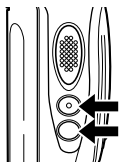

Press the **Lock** key to increment the Table number or the **Scan** key to decrement the number, to select the new key function

- Table numbers and their corresponding functions are provided in the table above.
- A voice announcement will inform you of the currently selected Table number.

5

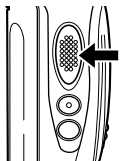

Press the **PTT** switch within 5 seconds to save the setting, otherwise the operation will cancel.

- A beep will sound and the transceiver will announce the new Table number.

6

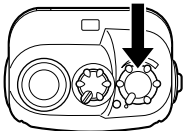

Turn the transceiver power **OFF** and then **ON** again to activate the new settings.

Note: The transceiver will automatically return to normal operation if no action is performed for 5 seconds.

CALLING ALERT

Calling alert tones are used to identify yourself to your party members and inform them that you are about to make a call. Your dealer can set up your transceiver with 1 of several different calling alert tones. If each party member uses a different calling alert tone, it is easy to know who is making the call

To make a call using the calling alert tone, press and hold the **PTT** switch, then press the key programmed as **Calling Alert**.

- The calling alert tone will transmit for the duration you press the **Calling Alert** key.

KEY LOCK

Press and hold the key programmed as **Key Lock** for 1 second to lock/ unlock the transceiver keys. The following keys/ functions can still be used when Key Lock is active: Autodial, Calling Alert, Key Lock, Monitor, Monitor Momentary, PTT, Squelch Off, Squelch Off Momentary, and Volume.

When the transceiver power is turned OFF and then ON again, the Key Lock function will be cancelled.

SUPER LOCK

Press and hold the key programmed as **Super Lock** for 4 seconds to lock the transceiver keys. The **PTT** switch and the **Power** switch/ **Volume** control can still be operated when Super Lock is active.

To deactivate Super Lock, with the transceiver power OFF, press and hold the **PTT** switch, the **Lock** key, and the **Scan** key for 2 seconds while turning the transceiver power ON.

MONITOR/ SQUELCH OFF

You can use the key programmed as **Monitor** or **Squelch Off** to listen to weak signals that you cannot hear during normal operation, to deactivate channel signaling, and to adjust the volume when no signals are present on your selected channel.

- **Monitor:** Momentarily press to deactivate Quiet Talk or Digital Quiet Talk signaling. Press the key again to return to normal operation.
- **Monitor Momentary:** Press and hold to deactivate Quiet Talk or Digital Quiet Talk signaling. Release the key to return to normal operation.
- **Squelch Off:** Momentarily press to hear background noise. Press the key again to return to normal operation.
- **Squelch Off Momentary:** Press and hold to hear background noise. Release the key to return to normal operation.

Note: The default Squelch level is set to 5 (out of 10). This value can be adjusted by your dealer.

SCAN

You can scan the channels of the transceiver to search for a signal. When the transceiver verifies a signal on a channel, it proceeds to check whether or not its QT/ DQT setting matches that which is set up on your transceiver (if any). If the QT/ DQT matches, the transceiver stops at the channel and opens the squelch so you can listen to the call. If the QT/ DQT does not match, the call is ignored and scanning continues.

Note: You can only use Scan if there are at least 2 channels available on your transceiver that are not locked out of Scan.

To start scanning, momentarily press the key programmed as either **Scan** or **Scan + Temporary Delete**.

- The LED indicator flashes green and scanning starts from the current channel and ascends through the channel numbers.
- When a signal is detected on a channel and the QT/ DQT matches, scan pauses at that channel and the LED indicator lights green.
- When the signal is no longer present, scanning continues after 3 seconds (default).

To end Scan, press the **Scan** or **Scan + Temporary Delete** key again.

■ Priority Scan

The Priority channel is a channel that is given first priority to while scanning. The Priority channel is set by your dealer.

During Scan, the transceiver will automatically change to the Priority channel when a call is received on it, even if a call is already being received on any of the other channels.

■ Temporary Delete

You can temporarily remove specific channels from the scanning sequence during Scan. When Scan pauses at a channel, you can remove that channel from the scanning sequence by pressing and holding the key programmed as **Temporary Delete** or **Scan + Temporary Delete** for 1 second.

- You cannot remove a channel if there will be less than 2 channels available for scanning remaining.
- To add the removed channels back into the Scan list, simply exit Scan mode or switch the transceiver power OFF and then ON again.

SCRAMBLER

Whereas the Quiet Talk and Digital Quiet Talk functions (page 15) allows you to ignore unwanted calls, Scrambler allows you to hold a conversation in complete privacy. When activated, any other party listening in on your channel will be unable to understand your conversation. The transceiver scrambles your voice so that anybody listening to your conversation will not be able to understand what you are saying.

In order for members of your own group to understand your call while you are using the Scrambler, all other members must also activate the Scrambler on their transceivers. This scrambles everybody's voice while transmitting and unscrambles the voice message on your own transceiver when you receive the message.

To activate the Scrambler, press the key programmed as **Scrambler**.

To deactivate the Scrambler, press the **Scrambler** key again.

RESETTING THE TRANSCEIVER

At some point in time, you may desire to reset the transceiver settings to their default values. This function will reset all channels to their default frequencies, the VOX function to its default status, and all keys to their default functions.

To reset the transceiver:

1



With the transceiver power OFF, press and hold the **PTT** switch, the **Lock** key, and the **Scan** key for 3 seconds while turning the transceiver power ON.

- Continue to hold the keys until the LED flashes orange one time.

2

Release the keys.

- The transceiver announces “Confirm” and returns to normal operation.

OPTIONAL ACCESSORIES

KMC-17 (Speaker/ microphone)

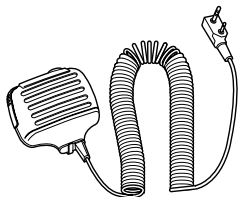

KMC-21 (Speaker/ microphone)

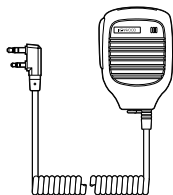

KHS-1 (Headset)

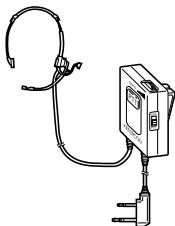

KHS-21 (Headset)



KWR-1 (Water resistant bag)

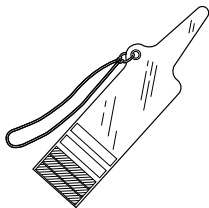

TROUBLESHOOTING GUIDE

Problem	Solution
Cannot turn the transceiver power ON.	<ul style="list-style-type: none">• The battery pack may be dead. Recharge or replace the battery pack.• The battery pack may not be installed correctly. Remove the battery pack and install again.
Battery power dies shortly after charging.	<ul style="list-style-type: none">• The battery pack life is finished. Replace the battery pack with a new one.
Cannot talk to or hear other members in your group	<ul style="list-style-type: none">• Make sure you are using the same frequency and QT/ DQT settings as the other members in your group.• Other group members may be using the Scrambler function. Turn on your transceiver's Scrambler.• Other group members may be too far away. Make sure you are within range of the other transceivers.
Other voices (besides group members') are present on the channel.	<ul style="list-style-type: none">• Change the QT/ DQT settings. Make sure all group members change the settings on their transceivers to match the new QT/ DQT setting.