



NAUTICO1 (NT1)
Owner's Guide

www.midlandradio.com

TABLE OF CONTENTS	1
Introduction.....	2
Important Notice, FCC Licensing.....	3
LCD Display	4
Controls	5
Battery Installation	6
Installing the Belt Clip	6
Charging the Optional Battery Pack	7
Operating Your Radio	7-12
External Speaker/Microphone Jack	12
Troubleshooting Guide	13
Use and Care	13
Specifications and Frequency Charts	13-16
Warranty Information	17
MIDLAND Family of Products	17
Accessories	18

Welcome to the world of Midland electronics

Congratulations on your purchase of a high quality MIDLAND product. Your 2-way radio represents the state-of-the-art in high-tech engineering. Designed for VHF Marine Service operation, this compact package is big on performance. It is a quality piece of electronic equipment, skillfully constructed with the finest components. The circuitry is all solid-state and mounted on a rugged printed circuit board. Your 2-way radio is designed to give you reliable and trouble-free performance for years to come.

Features

- Marine Channels: 57 USA / 61 Canada / 57 International (grouped by area)
- eVOX
- Selectable CALL Tone
- Weather (WX) Band Receiver
- SCAN Function
- MONITOR Function
- Roger Beep Tone
- Key Pad Lock
- Power High / Power Low Settings
- Speaker / Microphone Jacks
- Battery Indicator

This device complies with Part 15 of the FCC Rules. Operation is subject to the following two conditions : (1) this device does not cause harmful interference, and (2) this radio must accept any interference that may cause undesired operation.

To maintain compliance with FCC's RF exposure guidelines, for body-worn operation, this radio has been tested and meets the FCC RF exposure guidelines when used with Midland Radio Corp. accessories supplied or designated for this product. Use of other accessories may not ensure compliance with FCC RF exposure guidelines.

The Nautico1 operates on VHF Marine Radio Service frequencies, in compliance with Federal Communications Commission (FCC) requirements. Recreational boaters are not currently required to have a Ship Radio License. The USCG recommends that the boat's registration number and state be used for the radio call sign.

FCC License

A ship station license is not required for any vessel traveling in U.S. waters which is less than 20 meters in length. However, any vessel required to carry an HF SSB radiotelephone or marine satellite terminal is required to have a ship station license. FCC license forms can be downloaded at www.fcc.gov/forms. You may also obtain a form from the FCC by calling (888) 225-5322.

Exposure to Radio Frequency Energy

Your Midland radio is designed to comply with the following national and international standards and guidelines regarding exposure of human being to radio frequency electromagnetic energy:

- United States Federal Communications Commission, Code of Federal Regulations: 47 CFR part 2 sub-part J
- American National Standards Institute (ANSI)/Institute of Electrical & Electronic Engineers (IEEE) C95. 1-1992
- Institute of Electrical and Electronic Engineer (IEEE) C95. 1-1999 Edition
- National Council on Radiation Protection and Measurements (NCRP) of the United States, Report 86, 1986
- International Commission on Non-Ionizing Radiation Protection (ICNIRP) 1998

To control your exposure and ensure compliance with the general population or uncontrolled environment exposure limits, transmit no more than 50% of the time. The radio generates measurable RF energy exposure only when transmitting.

LCD DISPLAY

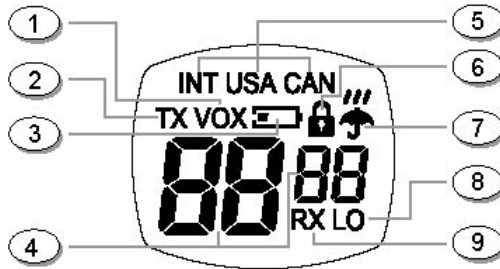

1. VOX – Indicates when eVOX mode is active.
2. TRANSMIT (TX) ICON – Indicates radio is transmitting a signal.
3. LOW BATTERY ICON – Indicates battery level is low.
4. CHANNEL NUMBER – Changes from 1~88a on VHF Marine band (1~10 on WX band).
5. USA/CAN/INT CHANNEL ICONS
6. KEY LOCK ICON – Indicates KEY LOCK mode is on.
7. WX BAND ICON – Indicates when the radio is in Weather Band mode
8. TRANSMIT POWER LEVEL (Hi / LO) ICON – Indicates TX Power setting.
9. RECEIVE (RX) ICON – Indicates radio is receiving a transmission.

CONTROLS

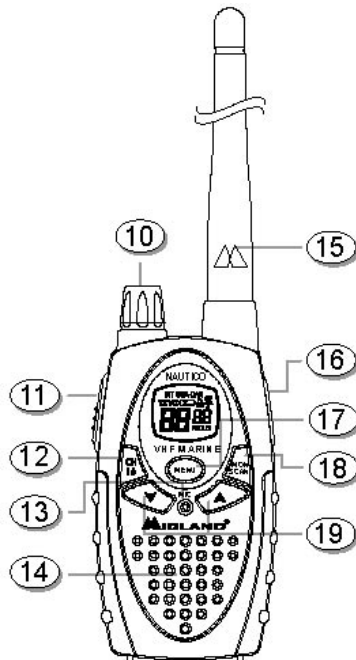

10. POWER/VOLUME KNOB – Turn clockwise to turn the power on and increase the volume level. Turn counter-clockwise to decrease the volume level and turn the power off.

11. PTT Button – Press and hold to transmit voice communication. Press twice quickly to send a call tone.

12. CH 16 Button – Press to switch immediately to emergency channel 16. Press and hold to switch to Channel 9.

13. MIC – Built-in microphone.

14. SPEAKER – Built-in speaker.

15. ANTENNA.

16. EXTERNAL SPEAKER/MIC JACK.

17. MENU Button – Press to access MENU mode. Press and hold to go to WX Band Receiver mode.

18. MONITOR/SCAN Button – Press to enter SCAN mode. Press and hold to enter MONITOR mode.

19. UP/DOWN Button – Make adjustments in MENU mode.

BATTERY INSTALLATION

Your Nautico1 radio operates with either 4 AA alkaline batteries or an optional NiMH battery pack. The belt clip should be removed (see below) to ease installation or removal of the batteries.

To install the batteries:

1. With the back of the radio facing you, remove the belt clip (see diagram below) for easy access, then remove the Battery Cover by pressing down on the top center and sliding it down from the radio.
2. Insert 4 AA batteries observing the polarity as shown. Installing the batteries incorrectly will prevent the radio from operating or may damage the radio.
3. Return the battery cover by sliding it up on the radio. Replace the belt clip, making sure it locks into place.

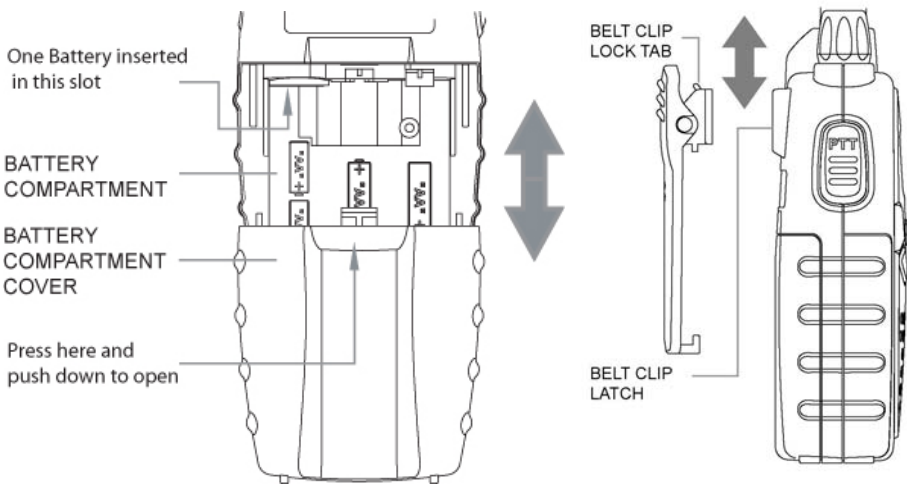

To install the **BELT CLIP**, slide the clip down into the slot on the back of the radio until the **BELT CLIP LATCH** clicks. To remove the **BELT CLIP**, press the **LOCK TAB** down, then gently pull the belt clip up toward the top of the radio.

RECHARGEABLE BATTERY & CHARGER OPTION

Your Nautico1 is equipped for using an optional rechargeable NiMH battery pack (not included) which can be recharged using an AC or DC charger (not included). Initial charge time is 24 hours with a charge time of 8-12 hours thereafter. For maximum battery life, we recommend charging the Nautico1 when the low battery indicator comes on. Remove the radio from the charger when the charge time expires.

To Charge Using Optional AC or DC Charger:

1. Place the rechargeable Ni-MH battery pack into the radio
2. Connect the AC adapter into an AC wall outlet
3. Insert the AC adapter plug (or DC Cigarette Lighter adapter if charging in vehicle) into the charging jack on the side of the radio.

	<ol style="list-style-type: none">1. Only use Midland NiMH battery pack.2. Do not attempt to charge alkaline batteries or any batteries or battery packs other than the one indicated in the manual. This may cause leakage and damage the radio.3. For long-term storage of the radio, turn the radio OFF and remove the batteries from the radio.
---	---

OPERATING YOUR RADIO

POWER ON/OFF AND VOLUME

Rotate the POWER/VOLUME knob clockwise to turn the radio on and increase the volume level. Rotate the control counter-clockwise to reduce the volume level and to turn the radio off. During Power On, the radio will beep 3 times with different tones, the LCD will display a "self-test" message for 1 second and the LCD display will indicate the last selected channel.

TRANSMITTING AND RECEIVING

1. To transmit a call, hold the radio 2 to 3 inches from your mouth.
2. Press and hold the PTT button and speak in a normal voice into the microphone. The TX icon will appear continuously on the LCD display while transmitting.
3. To receive a call, release the PTT button. The RX icon will appear on the display when your radio is receiving.

ABOUT RANGE

Your Nautico1 radio is designed to give you maximum range under optimum conditions.

Optimum Conditions are:

- Over water
- Open rural areas without obstructions
- Flat areas where you can see the other person

To ensure you get maximum range:

- Be sure to use fresh or fully charged batteries – low batteries will cause low power conditions
- Be sure the radio is set to high power

IN CASE OF EMERGENCY

If your vessel requires assistance, contact other vessels and the Coast Guard by sending a distress call on Channel 16.

○ USING CHANNEL 16

DISTRESS CALL PROCEDURE

1. "MAYDAY MAYDAY MAYDAY."
2. "THIS IS" (name of vessel)
3. Your call sign or other indication of the vessel.
4. "LOCATED AT" (your position)
5. The nature of the distress and assistance required.
6. Any other information which might facilitate the rescue.

NAUTICO 1 QUICK REFERENCE CHART

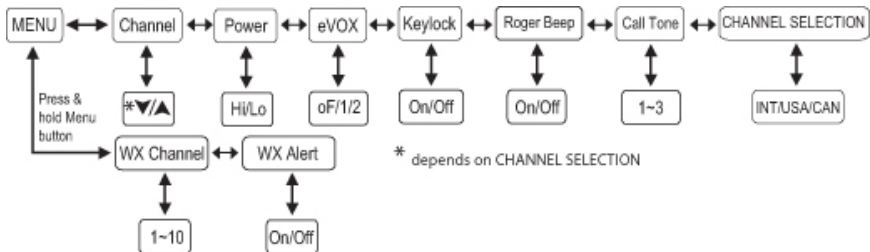

MONITOR

Pressing and holding the **MONITOR** button for 1 second will let you hear noise so you can adjust the volume level of the radio when not receiving a signal. This should be used to check activity on your current channel before transmitting. Press and release the **Monitor** button for 1 second to get out of **Monitor** mode.

SCAN

Your Nautico1 can scan all channels for activity. To enter, quickly press the **SCAN** button. Repeat the same procedure to exit. Your radio will rapidly scan each of the channels and stop on any active channel for 5 seconds before resuming scan. When you press the **PTT** button to transmit on an active channel, the scanning function will stop and remain on the active channel. To resume scanning, quickly press the  button.

INSTANT CHANNEL 16/9

Channel 16 (Distress Channel) is used for calling other stations or for distress alerting. You must monitor Channel 16 while standing by. Channel 16 is only to be used in emergency situations. You can also switch to Channel 9, the leisure-use call channel, without changing your normal channel by pressing and holding the **CH16** Button for 1 second. Pressing the **CH16** button again returns the radio to the normal channel setting

CALL TONE

Your Nautico1 can transmit a call tone for a fixed length of time. To send a call tone, press the **PTT** button twice within $\frac{1}{2}$ second. The **TX** icon will appear while transmitting a call tone and a tone can be heard on the speaker for confirmation.

KEYPAD LOCK

To avoid accidentally changing the radio setting, press the **MENU** button 4 times then press an up/down button to choose **ON**. The **KEY LOCK** icon will appear on the display. **PTT** and **CH 16** will still be active. To unlock the keypad, press the **MENU** button once, then press the  button to choose **OF**.

DISPLAY ILLUMINATION

During Power on, the display illumination will activate for approx. 7 seconds. The display illumination can also be activated when the **MENU** button is pressed.

CHANNEL SELECTION:

Press the MENU button once, and then the ▼▲ buttons to select one of the channels. To confirm the selection, press the PTT button or press MENU again to move to the next feature setting.

TRANSMIT (TX) POWER LEVEL SELECTION

The Nautico1 has 2 transmit power level settings. To select the power level on channels press the MENU button two times, a "P" icon will appear blinking on the display. Then press the ▼▲ button to select TRANSMIT POWER LEVEL icon (Hi / LO). The TX icon will be blank when Hi setting is selected. To confirm, press the PTT button or press MENU again to move to the next feature setting.

eVOX (Hands-free Transmission)

Your Nautico1 has 2 eVOX level settings: (oF/1/2). To set eVOX, press the MENU button three times. The display shows "eVOX" blinking while on the right of the CHANNEL NUMBER display, an "oF" icon appears. Select "1" or "2" by pressing the ▼▲ buttons and push the PTT key, or press MENU again to move to the next feature setting.

eVOX will be more sensitive on the "2" setting than on the "1" setting.

To turn eVOX off, press the MENU button three times. The display shows "VOX" blinking while on the right of the CHANNEL NUMBER display, a "1" or "2" icon appears. Select "oF" by pressing the ▼▲ buttons and push the PTT key, or press MENU to move to the next feature setting.

ROGER BEEP (end of transmission) TONE

When the PTT button is released, the radio will beep to confirm to other users that your transmission has finished. To turn the ROGER BEEP tone on, press the MENU button until the display shows an "rb" icon while on the right of the "rb" display, an "oF" icon appears. Select "on" by pressing the ▼▲ buttons and push the PTT key, or press MENU to move to the next feature setting.

To turn the ROGER BEEP tone off, press the MENU button until the display shows an "rb" icon while on the right of the "rb" display, an "on" icon appears. Select "oF" by pressing the ▼▲ buttons and push the PTT key, or press MENU to move to the next feature setting.

USA/CAN/INT CHANNEL SELECTION

The Nautico1 channel selection can be changed to follow rules of USA, Canada, or international rules. Press the MENU button until the current channel icon (USA, CAN , INT) flashes. Select a different channel list by pressing the ▼▲ buttons until the desired icon appears. Press the PTT key or press MENU to confirm.

CALL TONE SELECTION

Your Nautico1 has 3 user-selectable CALL TONES. To select, press the MENU button six times, so a "CA" icon appears and to the right of the "CA" icon the current CALL TONE setting is displayed. Then press the ▼▲ buttons to make the CALL TONE selections– the radio will emit a corresponding tone for each selection. To confirm, press the PTT button or press MENU to move to the next feature setting.

WEATHER (WX) BAND RECEIVER

Your Nautico1 has a WEATHER (WX) BAND RECEIVER function, to enable user to receive weather alert/reports from designated NOAA stations. To turn the WEATHER (WX) RECEIVER on, press and hold the MENU button for 3 seconds. The current WX CHANNEL and WX BAND icon will appear on the display. Press the MENU button and the ▼▲ buttons to select one of the 10 WX BAND channels. To confirm, press the PTT button or press MENU to move to the next feature setting. To turn the WEATHER (WX) RECEIVER off, press and hold the MENU button for 3 seconds. The current radio setting will be displayed and the WX BAND icon will go off.

WEATHER (WX) ALERT

Your Nautico1 has a WEATHER (WX) ALERT function, to enable user to automatically receive weather alert from designated NOAA stations. To turn the WEATHER (WX) ALERT on, press the MENU button twice while in WX Band. The display shows "AL", while on the right an "oF" icon appears blinking. Select "on" by pressing the ▼▲ buttons. To confirm, press the PTT button or press MENU. The radio will return to WX BAND and the WX BAND icon will continue blinking. If the radio receives a WX ALERT signal from a designated NOAA station while on MARINE Band, the radio will beep for 10 seconds while an "AL" and "In" icon appear on the display, after which will automatically go to WX BAND. If any button is pressed during beeping while on MARINE Band, the radio will automatically go to WX BAND.

To turn the WEATHER (WX) ALERT off, press the MENU button twice while in WX Band. The display shows "AL", while on the right an "on" icon appears blinking. Select "of" by pressing the ▼▲ buttons. To confirm, press the PTT button or press MENU.

EXTERNAL SPEAKER/MICROPHONE JACK

Your Nautico1 can be used with an optional external speaker/microphone or headset, freeing your hands for other tasks. To use an optional / speaker / microphone or headset:

- Insert the plug(s) into the SPK/MIC jacks
- Place the earbud into your ear, and adjust the mic into desired position.

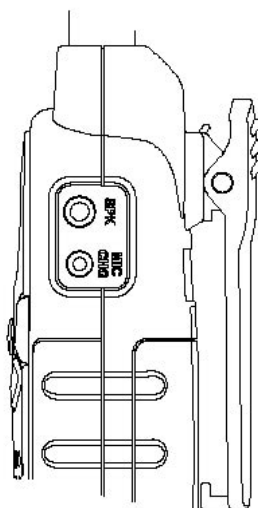

TROUBLESHOOTING GUIDE

PROBLEM	SOLUTION
No Power	Check battery installation and/or replace batteries
Cannot Receive Messages	Confirm the radios have the same channel settings.
	Make sure that you are within range of the other transceivers.
	Buildings and other structures may interfere with your communication. <i>See ABOUT RANGE on Page 8</i>
Radio is not responding to button presses	Make sure keypad lock is not on. See "Keypad Lock" (Page 11).
	Radio might need to be reset. Turn radio off then on again.
Display is dim	Recharge or replace batteries.
Charger not functioning	Contacts on the back of the radio may require cleaning.
	Ensure the outlet where the charger is plugged into is functioning properly.
	Check that the battery pack is installed in the radio properly.

USE AND CARE :

1. Use a soft, damp cloth to clean the radio
2. Do not use alcohol or cleaning solutions to clean the radio.
3. Do not immerse the radio in water.
4. Use a soft damp cloth to clean the radio
5. Dry the radio with dry lint-free cloth if the radio gets wet.
6. Turn off the radio and remove the batteries during long-term storage.

If you have a problem which you believe requires service, please call first and speak with a service technician. Many problems can be remedied over the phone without returning the unit for service.

SPECIFICATIONS

Channels 57 US, 61 CAN, 57 INT10 Weather (WX) Band Channels
 Operating Frequency VHF 156.025 ~ 162.550 MHz
 Power Source 4 AA Alkaline or 6.0V Rechargeable NiMH battery pack

FREQUENCY CHART (MHz)

Channel Number			Frequency MHz			.
INT	CAN	US	TX	RX	Mode	Note
01	01		156.050	160.650	D	
		01A	156.050	156.050	S	
02	02		156.100	160.700	D	
03	03		156.150	160.750	D	
04			156.200	160.800	D	
	04A		156.200	156.200	S	
05			156.250	160.850	D	
	05A	05A	156.250	156.250	S	
06	06	06	156.300	156.300	S	
07			156.350	160.950	D	
	07A	07A	156.350	156.350	S	
08	08	08	156.400	156.400	S	
09	09	09	156.450	156.450	S	
10	10	10	156.500	156.500	S	
11	11	11	156.550	156.550	S	
12	12	12	156.600	156.600	S	
13	13	13	156.650	156.650	S	
14	14	14	156.700	156.700	S	
15	15		156.750	156.750	S	*
		15	-	156.750	R	
16	16	16	156.800	156.800	S	
17	17	17	156.850	156.850	S	*
18			156.900	161.500	D	
	18A	18A	156.900	156.900	S	
19			156.950	161.550	D	
	19A	19A	156.950	156.950	S	
20	20*	20	157.000	161.600	D	
		20A	157.000	157.000	S	
21			157.050	161.650	D	
	21A	21A	157.050	157.050	S	
	21B		-	161.650	R	

INT	CAN	US	TX	RX	Mode	Note
22			157.100	161.700	D	
	22A	22A	157.100	157.100	S	
23	23		157.150	161.750	D	
		23A	157.150	157.150	S	
24	24	24	157.200	161.800	D	
25	25	25	157.250	161.850	D	
26	26	26	157.300	161.900	D	
27	27	27	157.350	161.950	D	
28	28	28	157.400	162.000	D	
60	60		156.025	160.625	D	
61			156.075	160.675	D	
	61A		156.075	156.075	S	
62			156.125	160.725	D	
	62A		156.125	156.125	S	
63			156.175	160.775	D	
		63A	156.175	156.175	S	
64	64		156.225	160.825	D	
	64A		156.225	156.225	S	
65			156.275	160.875	D	
	65A	65A	156.275	156.275	S	
66			156.325	160.925	D	
	66A*	66A	156.325	156.325	S	
67	67	67	156.375	156.375	S	
68	68	68	156.425	156.425	S	
69	69	69	156.475	156.475	S	
70	70	70	-	156.525	R	**
71	71	71	156.575	156.575	S	
72	72	72	156.625	156.625	S	
73	73	73	156.675	156.675	S	
74	74	74	156.725	156.725	S	
75			156.775	156.775	S	*
76			156.825	156.825	S	*
77	77*	77*	156.875	156.875	S	

INT	CAN	US	TX	RX	Mode	Note
78			156.925	161.525	D	
	78A	78A	156.925	156.925	S	
79			156.975	161.575	D	
	79A	79A	156.975	156.975	S	
80			157.025	161.625	D	
	80A	80A	157.025	157.025	S	
81			157.075	161.675	D	
	81A	81A	157.075	157.075	S	
82			157.125	161.725	D	
	82A	82A	157.125	157.125	S	
83	83		157.175	161.775	D	
	83A	83A	157.175	157.175	S	
84	84	84	157.225	161.825	D	
85	85	85	157.275	161.875	D	
86	86	86	157.325	161.925	D	
	87		157.375	161.975	D	
87			157.375	157.375	S	
	88		157.425	162.025	D	
88		88A	157.425	157.425	S	

S= Simplex

D= Duplex

***= obligatory low transmission power of 1 Watt**

****= classified to DSC communications**

(Nautico1) WEATHER (WX) RECEIVER FREQUENCY CHART (MHz)

CH. No	CH. Freq.	CH. No	CH. Freq.
1	162.550	6	162.500
2	162.400	7	162.525
3	162.475	8	161.650
4	162.425	9	161.775
5	162.450	10	163.275

Channels 8,9 and 10 are designated Canadian Marine Frequencies

LIMITED WARRANTY

Midland Radio Corporation will repair or replace, at its option without charge, any Midland VHF MARINE transceiver which fails due to a defect in material or workmanship within Three Years following the initial consumer purchase. This warranty does not apply to water damage, battery leak or abuse.

This warranty does not include any carrying cases, earphones or antennas, which may be a part of or included with the warranted product or the cost of labor for removal or re-installation of the product in a vehicle or other mounting. Performance of any obligation under this warranty may be obtained by returning the warranted product, freight prepaid, along with proof of purchase to:

Midland Radio Corporation
Warranty Service Department
5900 Parretta Drive
Kansas City, MO 64120

This warranty gives you specific legal rights and you may also have other rights, which vary from state to state. Note : The above warranty applies only to merchandise purchased in the United States of America or any of the territories or possessions thereof or from a U.S. Military exchange.

MIDLAND Family of Products



GMRS



Weather



CB Radio



VHF Marine

ACCESSORIES ORDER FORM

Please send Money Order or fill in Visa/Master Card information and mail to the address below. Please DO NOT sent cash or checks. Make Money Order to Midland Radio Corporation.

Name: _____

Address: _____

City: _____ **State** _____ **Zip Code** _____

Tel: _____ **email:** _____

CC# _____ **Type:** _____ **Exp.** _____

Qty	Item	Price	Total
	AVP-5	\$39.95	

Sub-Total _____
 Tax (MO, CO, IL, FL only) _____
 S&H (U.S. only) _____ \$8.95
 Total \$ _____

Mail To:
 Midland Radio Corporation
 Consumer. Dept.
 5900 Paretta Drive
 Kansas City MO 64120

 Or Call 816.241.8500.

 To order online go to
www.midlandradio.com

AVP5

- 1 Rechargeable Battery Pack
- 1 AC Charger
- 1 DC Charger
- 1 Mount Holder

**Midland Radio Corporation
Consumer. Dept.
5900 Parretta Drive
Kansas City, MO 64120
Or Call 816.241.8500.
<http://www.midlandradio.com>**

Note: Features & Specifications are subject to change without notice. MIDLAND is not responsible for unintentional errors or omissions on its packaging.